

Distributed by



www.centaur-asiapacific.com
info@centaur-asiapacific.com

Underhill® 2024

PROFESSIONAL PRODUCTS



**POWER
GULP™**



PowerFLOW Series

POWER Up Your Watering Game
with Underhill in 2024!

GOLF | SPORTS TURF | LANDSCAPE | D.I.Y.

NEW UNDERHILL PRODUCTS FOR 2024

POWER GULP™



PG 32

POWER SPLITTER



PG 17

ProLine™



Rubber Series
PG 8

Magnum™



Stinger

PG 15

CHECK OUT ALL THE NEW AND
IMPROVED PRODUCTS BROUGHT
TO YOU BY UNDERHILL!

Underhill®

WATERING PRODUCTS AND TOOLS

ULTRAMAX HOSE SELECTION CHART	3
ULTRAMAX BLUE PREMIUM HOSE	4
SHORTYPRO QUICK COOL/WASH HOSE	4
ULTRAMAX FEATHERWEIGHT HOSE	5
ULTRAMAX RED, ULTRAMAX GREEN HOSE	6
ULTRAMAX CLEAR HOSE, HOSE REPAIR FITTINGS	7
PROLINE FEATHERWEIGHT HOSE, PROLINE RUBBER HOSE	8
PROLINE GOLD, PURPLE SERIES, LIGHT DUTY HOSE	9
COURSE CADDIE TRAILER	10
HOSE CADDIE & FIELD CADDIE	11
TWIST-EASE KINK ELIMINATOR	12
PROLINE GOLD SERIES WATERING NOZZLES	13
MAGNUM ULTRAMAX PREMIUM PLUS NOZZLES	14
MAGNUM ULTRAMAX PREMIUM NOZZLES	15
MAGNUM STINGER NOZZLE, MAGNUM NOZZLE	15
HOSE END VALVES, COOLPRO NOZZLE	16
HOSE TAP SPLITTERS, HIGH-FLOW VALVE	17
POWERBLAST™ BRASS NOZZLES	18
DRAINBLASTER NOZZLES, RAINPRO NOZZLE	19
PRECISION SPECIFIC TASK NOZZLES, NOZZLE LOCKER KITS	20
BRASS POWER CONNECTS & SOLID BRASS ADAPTERS	21
DEEP DRIP STAKES, EASYOUT SPRINKLER REMOVAL TOOL	22
VERSALID REPLACEMENT LIDS	23
HOSETAP ADAPTERS, SPLICE KIT	24
THE EXTENDER, THE CLAW	25
ULTRA BRASS QUICK COUPLER KEYS & VALVES	26-27
ULTRA BRASS GOLD SERIES IMPACT SPRINKLERS	28-29
ROLLERPRO SPRINKLER BASE, SPOTSHOT KITS	30
SUPERKEY XL, EASYREACH KEY, DOUBLE-HEADER VALVE TOOL	31
POWERGULP™ WATER REMOVAL PUMPS & ACCESSORIES	32-33
GULP PRO/ BIG GULP PRO WATER REMOVAL PUMPS	34-35
TURFSPY GLASSES, TRACKER 2 IRRIGATION MACHINE	36
CATCHCAN ULTRA, AUDITMASTER TESTING KITS	37
PRESSURE CHECKER GAUGES & ACCESSORIES	38

PROMAX TURF MAINTENANCE & REPAIR

TURF TESTING & TURF REPAIR TOOLS	39-40
TURF LEVELING TOOLS	41
TURBO TRIM SPRINKLER HEAD TRIMMER/CUTTER	42
POWER TRIM SPRINKLER HEAD TRIMMER/CUTTER	43

PROFILE TORO & RAINBIRD SPRINKLER NOZZLES

PROFILE SOLID METAL GOLF SPRINKLER NOZZLES	44-45
--	-------

WETTING AGENTS & SPECIALTY PRODUCTS

TOURNAMENT-READY WETTING AGENT	46
MEDALIST, H2O MAXIMIZER LIQUID WETTING AGENT, HYDRO-WET INJECTABLE WETTING AGENT	47
TOURNAMENT-READY PLUS PELLETS WITH ACTOSOL, TOURNAMENT-READY PELLETS, H2O MAXIMIZER PELLETS	48
PELLETPRO APPLICATORS, WETTING AGENT SELECTION GUIDE	49
BENCHMARK FOAM MARKER, TANK CLEANER, ANTI-FOAM AGENT K-KLEAN TANK CLEANER, BIO-90 ADJUVANT, WATER FX CONDITIONER	50
LIQUIDPRO APPLICATORS, FLO-PRO INLINE APPLICATOR	51

MARKING SYSTEMS & TOOLS

SPRINKLER HEAD YARDAGE MARKERS	52-54
MERCHANDISING UNDERHILL PRODUCTS	55



UltraMax™ Blue

- Best combination of weight, durability, flexibility, pressure strength & flow rate
- Soft & flexible - won't scuff greens
- Available in 3/4" GHT & 1" NPSH

≈ 1200 psi Burst / 300 psi Operating
 ≈ \$\$\$\$ - Premium Quality
 ≈ 3/4" = 27 lbs, 1" = 43 lbs (per 100 ft)
 ≈ Best Professional PVC Hose



UltraMax™ Featherweight

- Extremely lightweight, high pressure rating, highly kink resistant, easy to roll & maneuver
- Smooth outer fabric slides over turf without scuffing
- Available in 3/4" GHT & 1" NPSH

≈ 1200 psi Burst / 300 psi Operating
 ≈ \$\$\$\$ - Premium Quality
 ≈ 3/4" - 9 lbs, 1" = 15 lbs (per 100 ft)
 ≈ Lightest Professional Hose



UltraMax™ Red

- Ultimate choice for long life under heavy use
- Made of EPDM synthetic rubber
- Kink, tangle & weather resistant
- Available in 3/4" GHT & 1" NPSH

≈ 800 psi Burst / 200 psi Operating
 ≈ \$\$\$\$ - Heavy Duty
 ≈ 3/4" = 38 lbs, 1" = 59 lbs (per 100 ft)
 ≈ Best Longevity and Ability to Drag



UltraMax™ Green

- Lightweight with a high burst pressure rating
- Smooth outer texture won't scuff greens
- Thick, durable outer wall
- Available in 3/4" GHT & 1" NPSH

≈ 800 psi Burst / 200 psi Operating
 ≈ \$\$\$ - Professional Quality
 ≈ 3/4" = 28 lbs, 1" = 38 lbs (per 100 ft)
 ≈ Lighter Weight & Smooth Exterior



UltraMax™ Clear

- Lightweight & economical
- Thick, durable outer wall
- Ideal for light to medium commercial duty
- Available in 3/4" GHT & 1" NPSH

≈ 600 psi Burst / 150 psi Operating
 ≈ \$\$\$ - Professional Quality
 ≈ 3/4" = 20 lbs, 1" = 32 lbs (per 100 ft)
 ≈ Lightweight & Economical



ProLine™ Featherweight

- Extremely lightweight
- Tough outer polyester fabric stands up to wear and tear
- Outer springs prevent bending/kinking at connections
- Available in 3/4" GHT

≈ 800 psi Burst / 200 psi Operating
 ≈ \$\$\$ - Premium Quality
 ≈ 3/4" = 9 lbs (per 100 ft)
 ≈ Lightest Commercial Hose



ProLine™ Gold

- Economical multi-purpose, commercial quality hose
- Made from the same material as UltraMax™ blue hose
- Flexible & lightweight with Zero-Kink technology
- Available in 5/8" & 3/4" (both with 3/4" GHT connections)

≈ 500 psi Burst / 125 psi Operating
 ≈ \$\$ - Commercial Quality
 ≈ 5/8" = 15 lbs, 3/4" = 20 lbs (per 100 ft)
 ≈ Commercial / Residential Use



ProLine™ Rubber

- 20% lighter than standard rubber hose
- Tough rubber material is abrasion resistant
- Handles hot water up to 212°F
- Available in 5/8" & 3/4" (both with 3/4" GHT connections)

≈ 500 psi Burst / 150 psi Operating
 ≈ \$\$ - Commercial Quality
 ≈ 5/8" = 21 lbs, 3/4" = 27 lbs (per 100 ft)
 ≈ Agricultural & Commercial Use



ProLine™ Light Duty

- Perfect for Light-Duty Use
- Smooth finish & lightweight
- Standard 3/4" hose thread brass couplings
- Available in 5/8" x 50 ft length

≈ 300 psi Burst / 100 psi Operating
 ≈ \$ - Residential Quality
 ≈ 5/8" = 5 lbs (per 50 ft)
 ≈ Affordable, Residential Hose

Underhill® ULTRAMAX™ HOSES

FEATURING OUTSTANDING DURABILITY AND PERFORMANCE.

Underhill UltraMax™ hose employs the highest standard of precision engineering in design and manufacturing.

PREMIUM GRADE

UltraMax™ Blue

All weather performance in an **ULTRA FLEXIBLE** lightweight hose. Up to 45% lighter than comparable commercial quality hose. Made of super, heavy-duty, longlife flexible TPE material.

Don't Settle for Less, Choose the Best!

features

- 1200 psi Burst Pressure
- All Weather Performance
- Machined Brass Couplings
- Won't Scuff Turf on Greens
- Abrasive Resistant



SCAN

to learn more!



ShortyPro™ QUICK COOL/WASH BLUE HOSE

Finally, the right hose for the job! No more extra hose to carry around when you don't need it. Ideal for quick green and tee syringe, also equipment wash down.



Hose Weight for 100' (30.48m)

3/4" UltraMax Blue	27 lbs. (12.3 kg)
1" UltraMax Blue	43 lbs. (19.5 kg)

Custom Lengths, Quick Turnaround!

ordering UltraMax™ Blue Hose

Part # H75-025B	3/4" UltraMax Hose BLUE; 25' Length
Part # H75-050B	3/4" UltraMax Hose BLUE; 50' Length
Part # H75-075B	3/4" UltraMax Hose BLUE; 75' Length
Part # H75-100B	3/4" UltraMax Hose BLUE; 100' Length
Part # H75-125B	3/4" UltraMax Hose BLUE; 125' Length
Part # H75-CB	3/4" UltraMax Hose BLUE; Custom Length; (fittings not included with custom hose)
Part # H75GB	3/4" Male GHT Fitting, 3/4" Female GHT Fitting, 2 Ferrules for use on GREEN / BLUE custom hose
Part # H10-025B	1" UltraMax Hose BLUE; 25' Length
Part # H10-050B	1" UltraMax Hose BLUE; 50' Length
Part # H10-075B	1" UltraMax Hose BLUE; 75' Length
Part # H10-100B	1" UltraMax Hose BLUE; 100' Length
Part # H10-125B	1" UltraMax Hose BLUE; 125' Length
Part # H100-CB	1" UltraMax Hose BLUE; Custom Length; (fittings not included with custom hose)
Part # H100CGRB	1" Male NPSH Fitting, 1" Female NPSH Fitting, 2 Ferrules for use on custom hose

ShortyPro™ Blue Hoses

Part #: H75-S10	3/4" ShortyPro Blue Hose; 10' Length
Part #: H75-S20	3/4" ShortyPro Blue Hose; 20' Length
Part #: H10-S10	1" ShortyPro Blue Hose; 10' Length
Part #: H10-S20	1" ShortyPro Blue Hose; 20' Length

FEATHERWEIGHT GRADE

NEW!

UltraMax™ Featherweight

NEW & IMPROVED! OUR NEWEST GENERATION OF FEATHERWEIGHT HOSE COMES WITH OUR EXCLUSIVE POWERFLOW TECHNOLOGY THAT PROVIDES THE SAME HIGH FLOW RATES AS STANDARD PVC AND RUBBER HOSES.

UltraMax™ Featherweight's new weave pattern still provides a smooth surface that glides across turf without scuffing while adding a new layer of durability and kink resistance.

NEW HIGH FLOW RATE!



PowerFLOW Series

features

- 1200 psi Burst Pressure
- Ultra-Smooth outer polyester fabric slides across turf without scuffing
- Rubber Guards on both ends prevent kinking
- **EXTREMELY LIGHTWEIGHT!** 1" x 100' weighs 15 pounds
- Aluminum ergonomic fittings for easy connection
- Now available in ¾" or 1"

Featherweight - Easy to Maneuver, Roll and Kink Resistant



Hose Weight for 100' (30.48m)

¾" UltraMax Featherweight	9 lbs. (4.1 kg)
1" UltraMax Featherweight	15 lbs. (6.8kg)

ordering UltraMax™ Featherweight Hose

Part # H75-050FW	¾" Featherweight Hose; 50' Length
Part # H75-075FW	¾" Featherweight Hose; 75' Length
Part # H75-100FW	¾" Featherweight Hose; 100' Length
Part # H75-125FW	¾" Featherweight Hose; 125' Length
Part # H10-050FW	1" Featherweight Hose; 50' Length
Part # H10-075FW	1" Featherweight Hose; 75' Length
Part # H10-100FW	1" Featherweight Hose; 100' Length
Part # H10-125FW	1" Featherweight Hose; 125' Length
Part # H10-150FW	1" Featherweight Hose; 150' Length
Part # H75-S20FW	¾" Featherweight ShortyPro; 20' Length
Part # H10-S20FW	1" Featherweight ShortyPro; 20' Length

THE HOSE BUILT FOR PROFESSIONAL TURF MANAGERS

HEAVY DUTY GRADE

UltraMax™ Red

ULTRAMAX RED IS THE ULTIMATE CHOICE FOR LONG LIFE UNDER HEAVY JOBS THAT REQUIRE DRAGGING OVER RUGGED TERRAIN.

Featuring outstanding durability and performance, Underhill UltraMax™ Red hose employs the highest standard of precision engineering in design and manufacturing. UltraMax™ Red is the ultimate choice for long life under heavy use...made of EPDM synthetic rubber and reinforced with spiral synthetic yarn for extra strength under high working pressure. *Don't settle for less, choose the best!*

features

- 800 psi Burst Pressure
- Machined Brass Couplings
- Kink, Tangle & Abrasion Resistant



Hose Weight for 100' (30.48m)

3/4" UltraMax Red	38 lbs. (17kg)
1" UltraMax Red	59 lbs. (27kg)



LIGHTWEIGHT GRADE

UltraMax™ Green

SMOOTH FINISH AND LIGHTWEIGHT WITH HIGH BURST PRESSURE RATING

Made of Pliovic material with extra burst pressure performance. Suitable for a wide range of multi-purpose commercial applications.

features

- 800 psi Burst Pressure
- Lightweight,
- Machined Brass Couplings
- Durable Thick Outer Wall
- Non-Conductive Hose
- Very Smooth Finish



Hose Weight for 100' (30.48m)

3/4" UltraMax Green	28 lbs.(12.7kg)
1" UltraMax Green	38 lbs. (17.3kg)

ordering UltraMax-Red Hose

- Part # H75-025R 3/4" UltraMax Hose RED; 25' Length
- Part # H75-050R 3/4" UltraMax Hose RED; 50' Length
- Part # H75-075R 3/4" UltraMax Hose RED; 75' Length
- Part # H75-100R 3/4" UltraMax Hose RED; 100' Length
- Part # H75-125R 3/4" UltraMax Hose RED; 125' Length
- Part # H75-CR 3/4" UltraMax Hose RED; Custom Length; (fittings not included with custom hose)
- Part # H75R 3/4" Male GHT Fitting, 3/4" Female GHT Fitting, 2 Ferrules for use on RED custom hose
- Part # H10-025R 1" UltraMax Hose RED; 25' Length
- Part # H10-050R 1" UltraMax Hose RED; 50' Length
- Part # H10-075R 1" UltraMax Hose RED; 75' Length
- Part # H10-100R 1" UltraMax Hose RED; 100' Length
- Part # H10-125R 1" UltraMax Hose RED; 125' Length
- Part # H100-CR 1" UltraMax Hose RED; Custom Length; (fittings not included with custom hose)
- Part # H100CGRB 1" Male NPSH Fitting, 1" Female NPSH Fitting, 2 Ferrules for use on custom hose

ordering UltraMax-Green Hose

- Part # H75-025G 3/4" UltraMax Hose GREEN; 25' Length
- Part # H75-050G 3/4" UltraMax Hose GREEN; 50' Length
- Part # H75-075G 3/4" UltraMax Hose GREEN; 75' Length
- Part # H75-100G 3/4" UltraMax Hose GREEN; 100' Length
- Part # H75-125G 3/4" UltraMax Hose GREEN; 125' Length
- Part # H75-CG 3/4" UltraMax Hose GREEN; Custom Length; (fittings not included with custom hose)
- Part # H75GB 3/4" Male GHT Fitting, 3/4" Female GHT Fitting, 2 Ferrules for use on GREEN / BLUE custom hose
- Part # H10-025G 1" UltraMax Hose GREEN; 25' Length
- Part # H10-050G 1" UltraMax Hose GREEN; 50' Length
- Part # H10-075G 1" UltraMax Hose GREEN; 75' Length
- Part # H10-100G 1" UltraMax Hose GREEN; 100' Length
- Part # H10-125G 1" UltraMax Hose GREEN; 125' Length
- Part # H100-CG 1" UltraMax Hose GREEN; Custom Length; (fittings not included with custom hose)
- Part # H100CGRB 1" Male NPSH Fitting, 1" Female NPSH Fitting, 2 Ferrules for use on custom hose

LIGHTWEIGHT GRADE

UltraMax™ Clear

SMOOTH FINISH AND LIGHTWEIGHT

An economical multi-purpose clear hose...made of clear Pliovic material and reinforced spiral yarn for extra strength. Ideal for light to medium commercial duty including golf course greens.

features

- 600 psi Burst Pressure
- Machined Brass Couplings
- Non-Conductive Hose
- Lightweight, Durable And Thick Outer Wall
- Very Smooth Finish



Hose Weight for 100' (30.48m)	
3/4" UltraMax Clear	20 lbs. (9kg)
1" UltraMax Clear	32 lbs. (14.5kg)

Hose Repair

HOSE MENDER CLAMPS - SUPER HEAVY DUTY Designed to do the job right and built to last. Made of Zinc, Stainless Steel and ED finish.



MEND THOSE VALUABLE HOSES!

SOLID BRASS - ULTRA-RELIABLE For reliable, crush proof, high-performance year after year, you just can't beat our machined brass hose repair fittings.

ordering UltraMax-Clear Hose

- Part # H75-025C 3/4" UltraMax Hose CLEAR; 25' Length
- Part # H75-050C 3/4" UltraMax Hose CLEAR; 50' Length
- Part # H75-075C 3/4" UltraMax Hose CLEAR; 75' Length
- Part # H75-100C 3/4" UltraMax Hose CLEAR; 100' Length
- Part # H75-125C 3/4" UltraMax Hose CLEAR; 125' Length
- Part # H75-CC 3/4" UltraMax Hose CLEAR; Custom Length; (fittings not included with custom hose)
- Part # H75C 3/4" Male GHT Fitting, 3/4" Female GHT Fitting, 2 Ferrules for use on CLEAR custom hose
- Part # H10-025C 1" UltraMax Hose CLEAR; 25' Length
- Part # H10-050C 1" UltraMax Hose CLEAR; 50' Length
- Part # H10-075C 1" UltraMax Hose CLEAR; 75' Length
- Part # H10-100C 1" UltraMax Hose CLEAR; 100' Length
- Part # H10-125C 1" UltraMax Hose CLEAR; 125' Length
- Part # H100-CC 1" UltraMax Hose CLEAR; Custom Length; (fittings not included with custom hose)
- Part # H100CGRB 1" Male NPSH Fitting, 1" Female NPSH Fitting, 2 Ferrules for use on custom hose



Male Hose Mender Female Hose Mender Coupling Worm Clamp

ordering Hose Clamps - Super Heavy Duty

- Part # HR-58F (5/8") Clamp with Female Brass Mender
- Part # HR-58M (5/8") Clamp with Male Brass Mender
- Part # HR-58C (5/8") Clamp (2) with Coupling Mender
- Part # HR-75F (3/4") Clamp with Female Brass Mender
- Part # HR-75M (3/4") Clamp with Male Brass Mender
- Part # HR-75C (3/4") Clamp (2) with Coupling Mender

ordering Hose Menders - Ultra Reliable

- Part # HRBM-10-C Hose Repair 1" Coupling Brass Mender
- Part # HRBM-10-F Hose Repair 1" Female Brass Mender
- Part # HRBM-10-M Hose Repair 1" Male Brass Mender
- Part # HRBM-58-C Hose Repair 5/8" Coupling Brass Mender
- Part # HRBM-58-F Hose Repair 5/8" Female Brass Mender
- Part # HRBM-58-M Hose Repair 5/8" Male Brass Mender
- Part # HRBM-75-C Hose Repair 3/4" Coupling Brass Mender
- Part # HRBM-75-F Hose Repair 3/4" Female Brass Mender
- Part # HRBM-75-M Hose Repair 3/4" Male Brass Mender
- Part # HWC-050-125 Hose Worm Clamp; (For OD's 1/2" to 1 1/4"); Use with 5/8" Hose or 3/4" Hose
- Part # HWC-075-175 Hose Worm Clamp; (For OD's 3/4" to 1 3/4"); Use with 3/4" Hose or 1" Hose

*Do The Job Right,
Built To Last!*

FEATHERWEIGHT

ProLine™ Featherweight

CRAFTED FROM THE SAME TECHNOLOGY WE USED TO CREATE OUR FEATHERWEIGHT ULTRAMAX, WE'VE CREATED A LIGHTER DUTY VERSION FOR THE COMMERCIAL USER.

A special, high flow rate version of 3/4" hose that is incredibly light, but still tough. Easy to get in and out of a truck and work around plants and flowers.



PowerFLOW Series

Hose Weight for 100' (30.48m)

3/4" ProLine Featherweight

9 lbs. (4.08kg)

features

- **800 PSI** Burst Pressure
- **EXTREMELY LIGHTWEIGHT!**
- Tough, outer polyester fabric stands up to wear and tear
- 3/4" GHT crimped Brass connections
- Outer springs prevent bending or kinking at points of connection

ordering ProLine™ Featherweight Hose

Part # H75-050PRO-FW 3/4" GHT Featherweight Hose; 50' Length
 Part # H75-075PRO-FW 3/4" GHT Featherweight Hose; 75' Length
 Part # H75-100PRO-FW 3/4" GHT Featherweight Hose; 100' Length

COMMERCIAL GRADE

NEW!

ProLine™ Rubber Hose

OUR NEW PROLINE RUBBER IS INNOVATIVE TECHNOLOGY THAT GIVES YOU THE RUGGED DURABILITY OF RUBBER HOSE WITH 20% LESS WEIGHT TO MAKE IT EASIER TO HANDLE.

Proline Rubber offers flexibility in all temperatures, and is hot water rated.

features

- **500 PSI** Burst Pressure
- 100% Rubber Construction
- Handles Hot Water Up to 212°F
- Machined Brass 3/4" Fittings
- 20% Lighter Hose than Standard Rubber Hose
- Easy to maneuver, roll and kink resistant



ordering ProLine™ Rubber Series Hose

Part # H58-015PRO-R 5/8" ProLine Rubber Series; 15' Length
 Part # H58-025PRO-R 5/8" ProLine Rubber Series; 25' Length
 Part # H58-050PRO-R 5/8" ProLine Rubber Series; 50' Length
 Part # H58-075PRO-R 5/8" ProLine Rubber Series; 75' Length
 Part # H58-100PRO-R 5/8" ProLine Rubber Series; 100' Length
 Part # H75-025PRO-R 3/4" ProLine Rubber Series; 25' Length
 Part # H75-050PRO-R 3/4" ProLine Rubber Series; 50' Length
 Part # H75-075PRO-R 3/4" ProLine Rubber Series; 75' Length
 Part # H75-100PRO-R 3/4" ProLine Rubber Series; 100' Length
 Part # H75-125PRO-R 3/4" ProLine Rubber Series; 125' Length



COMMERCIAL GRADE

ProLine™ Gold Series

SMOOTH FINISH AND LIGHTWEIGHT WITH MODERATE BURST PRESSURE RATING.

An economical multi-purpose hose made of super heavy duty, long life flexible TPE, the same material as our top of the line UltraMax Blue Hose, but with lower rating burst pressure.

Not recommended for high pressure applications.

features

- ZERO-KINK technology
- 500 psi Burst Pressure
- Machined Brass Couplings
- Lightweight, Durable



Hose Weight for 100' (30.48m)	
5/8" Gold Series	14.25 lbs. (6.5kg)
3/4" Gold Series	20.2 lbs. (9.2kg)

ordering

Part # H58-050PRO-G	5/8" ProLine Hose Gold; 50' Length
Part # H58-075PRO-G	5/8" ProLine Hose Gold; 75' Length
Part # H58-100PRO-G	5/8" ProLine Hose Gold; 100' Length
Part # H75-050PRO-G	3/4" ProLine Hose Gold; 50' Length
Part # H75-075PRO-G	3/4" ProLine Hose Gold; 75' Length
Part # H75-100PRO-G	3/4" ProLine Hose Gold; 100' Length



ProLine™ PURPLE Series Hose

SMOOTH FINISH WITH MODERATE BURST PRESSURE RATING

Finally an economical multi-purpose hose solution with the same construction specifications as our popular Proline Gold Series hose.

- ZERO-KINK technology
- 500 psi Burst Pressure
- Machined Brass couplings
- Lightweight and durable

Hose Weight for 100' (30.48m)	
3/4" ProLine Purple Series Hose	20.2 lbs. (9.2kg)

ordering

Part # H75-050PRO-P	3/4" Proline Hose Purple; 50' Length
Part # H75-075PRO-P	3/4" Proline Hose Purple; 75' Length
Part # H75-100PRO-P	3/4" Proline Hose Purple; 100' Length

SCAN
to learn more!



For store merchandising, ask your Underhill representative how you can receive a **FREE Super Tower Display** with a minimum purchase starter program!



MADE IN USA



ProLine™ Light Duty Hose

SMOOTH FINISH & LIGHTWEIGHT / MODERATE BURST PRESSURE

Perfect for light-duty use and light weight enough to make it very easy to handle. Standard 3/4" hose thread brass couplings.

- 300 psi Burst Pressure
- 5/8" diameter / 50 ft length
- Machined Brass couplings
- Pallet wrapped, ready to sell!

Hose Weight for 50' (15.24m)	
5/8" ProLine Light Duty	5 lbs. (2.27kg)

ordering

Part # H58-050LW	5/8" Light Duty Hose; 50' Length
------------------	----------------------------------

Course Caddie™ Hose Reel Trailer

Course Caddie™ Premium Hose Reel Trailer

HOSE AT YOUR FINGERTIPS WITH AN EMPTY UTILITY BED FOR EVERYTHING ELSE!

Stop lifting heavy hose in and out of your utility vehicle. Our Course Caddie™ Trailer is perfectly designed in strength and function for professional turf managers. We thought out every detail from the high flow Hose Caddie Reel mounted securely to the trailer to the full size golf cart tires and hubs for a smooth and quiet ride.

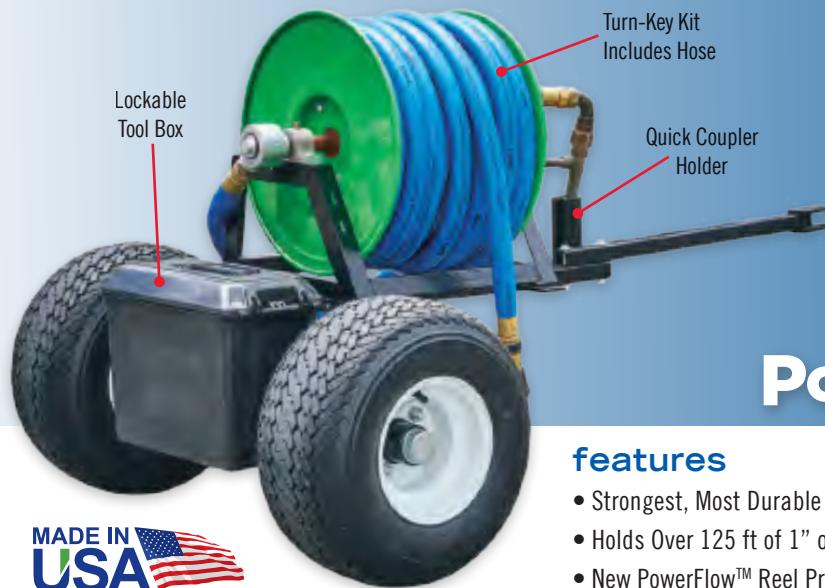

PowerFLOW Series



features

- Strongest, Most Durable Hose Trailer on the Market
- Holds Over 125 ft of 1" or 150 ft of ¾" Hose
- New PowerFlow™ Reel Provides Highest Possible Flow Rate
- Includes a 10 ft UltraMax™ Blue Leader Hose
- Includes Convenient Quick Coupler Key Mount
- Connects to Any Flat Bar Hitch
- Full Size Golf Cart Tires & Hubs
- Optional High Quality Tool Box with Lockable Top Fits Most Tools & Accessories
- Replacement Parts Readily Available



ordering

- | | |
|---------------------|--|
| Part # HC-TRL-075 | ¾" Hose Reel mounted to trailer w/ ¾" x 10 ft Leader Hose |
| Part # HC-TRL-100 | 1" Hose Reel mounted to trailer w/ 1" x 10 ft Leader Hose |
| Part # HC-TRL-TOOL | Optional Tool Box, includes mounting hardware |
| Part # HC-TRL-075-K | Turnkey ¾" Kit - Includes Course Caddie, Tool Box and ¾" x 125 ft UltraMax Blue Hose |
| Part # HC-TRL-100-K | Turnkey 1" Kit - Includes Course Caddie, Tool Box and 1" x 100 ft UltraMax Blue Hose |

HOSE Caddie™ & Field Caddie™

Hose Caddie™

NEW & IMPROVED!

NO MORE LIFTING, TWISTING, FIGHTING OR WINDING HOSE IN AND OUT OF A UTILITY CART!

Our New and Improved Hose Caddie™ now holds 25% more hose, comes with our PowerFlow™ technology for maximum flow rates, and now has an optional hose guide for easier winding. Hose Caddie™ is powder coated finish for superior rust resistance. The Hose Caddie™ is available in 1" or ¾" hose versions.

PowerFLOW Series



features

- Now Carries Over 125 ft of 1" or 150 ft of ¾" Hose
- Quick Coupler Key Holder Mounted to Frame
- New PowerFlow™ Internal Parts Provides Highest Possible Flow Rate
- Optional Hose Guide Mounts to Reel for Easy Winding
- Includes a 10 ft UltraMax Blue Leader Hose
- Base has 4 Pre-Drilled Holes for Easy Mounting

Field Caddie™

THE FIELD CADDIE™ IS DESIGNED FOR THE SPORTS TURF PROFESSIONAL. MAXIMUM DURABILITY, NO FLAT TIRES, GREAT LEVERAGE TO MAKE IT EASY TO BRING A HOSE ON AND OFF A FIELD WITH EASE!

Our Field Caddie™ is the strongest, most durable hose cart with all the professional features of our Hose Caddie™ reel.

features

- Holds Over 100 ft of 1" Hose or 125 ft of ¾" Hose
- Heavy Duty Hand Truck Frame Easily Maneuvers Hose On/Off the Field
- Solid Rubber Wheels Never Go Flat and Heavy Duty Bearings to Ensure Durability
- Quick Coupler Key Holder keeps Quick Coupler Key out of the way and accessible
- Includes a 10 ft UltraMax™ Blue Leader Hose
- Tool Box Available as Optional Add-On
- Available in 1" or ¾" Hose Versions



ordering

Part # HC-075	Hose Caddie Reel, ¾" Model
Part # HC-100	Hose Caddie Reel, 1" Model
Part # HC-HG	Optional Hose Guide for Hose Caddie Reel
Part # HC-HT-075	Field Caddie Hose Cart w/ Reel, 10 ft Leader Hose - ¾" Model
Part # HC-HT-100	Field Caddie Hose Cart w/ Reel and 10 ft Leader Hose - 1" Model
Part # HC-TRL-TOOL	Optional Tool Box, includes mounting hardware

MADE IN USA

Twist-Ease™ Kink Eliminator

Twist-Ease™

BRASS FITTING REMOVES KINKS ON ANY HOSE!

Never waste time getting kinks and tangles out of your hose, the Twist-Ease free-spin swivel makes untangling your hose easier than ever before. Install the Twist-Ease between your hose and nozzle and your ready to get to work!

Never Fight with a Tangled Hose Again!



features

- High Quality, High Flow, Brass Swivel that fits between your Hose and Nozzle
- Simply pull the Hose by the Nozzle and All Twists, Kinks and Tangles will Spin Out with the Swivel making untangling your Hose a Breeze!
- Available in 1" NPSH or 3/4" GHT



SCAN to learn more!



ordering

- Part # HSF-75 Twist-Ease™ 3/4" Kink Eliminator
Part # HSF-100 Twist-Ease™ 1" Kink Eliminator

Prevents Hose Kinking, Twisting or Crimping

Professional's Choice Watering Products

PRO-LEVEL WATERING NOZZLES for landscape turf or plant watering - Low to Medium flow pressure applications

Pattern Master™

Multi-Pattern Spray Nozzle

features

- EASY THUMB CONTROL
- 7 Easy-Click Selectable Patterns
- Metal-Zinc / Brass Construction
- Fits 3/4" Hose Thread Inlet



ProSpray™

Variable Spray Gun

features

- EASY THUMB CONTROL
- Smooth Operation
- Metal-Zinc / Brass Construction
- Fits 3/4" Hose Thread Inlet



Pattern Master™

Multi-Pattern Spray Nozzle

features

- Trigger Flow Control
- 8 Easy-Click Selectable Patterns
- Metal-Zinc / Brass Construction
- Fits 3/4" Hose Thread Inlet



ProSpray™

Variable Spray Gun

features

- Trigger Flow Control
- Smooth Trigger Operation
- Metal-Zinc / Brass Construction
- Fits 3/4" Hose Thread Inlet



Pattern Master Multi-Spray

Gold Series



ProSpray Variable Spray

Magnum-Mini™

Adjustable Spray Nozzle

Ideal for turf or plant watering, equipment washdown, seed beds.

features

- Easy Adjusting
- No Leak Design
- Compact – High Performance
- Ideal Nozzle for Low - Medium Pressure Applications
- Fits 3/4" Hose Thread Inlet



Extender™ Wand

Wand Spray Nozzle

Telescoping feature with ratchet adjusts head. Super soft pattern & easy click selection.

features

- Smooth Trigger Operation, No Leak Design
- Full Telescoping Handle from 28" To 41" Length
- Metal-Zinc / Brass Construction
- Fits 3/4" Hose Thread Inlet



320° Ratcheting Spray Head

Long



PushSmart On/Off

Short



ordering

- Part # NG250-8S PatternMaster™ Gold Series Multi-Pattern - Thumb Control
- Part # NG250-P ProSpray™ Gold Series Variable Spray - Thumb Control
- Part # NG200-8S PatternMaster™ Gold Series Multi-Pattern Spray
- Part # NG200-P ProSpray™ Gold Series Variable Spray
- Part # NG350 Magnum-Mini™ Gold Series Adjustable Spray
- Part # NG200-TW Extender™ Gold Series Wand Spray

Magnum™ UltraMAX *Premium Plus* PRO Series

MADE OF SUPER HEAVY DUTY METAL ALLOY, AND TPR RUBBER



Step up to the most professional nozzle you can buy - MAGNUM™ UltraMax Firefighter quality for professionals in any field, these variable flow, multi-function nozzles are virtually indestructible and leak proof. The innovative TURBO SHIFT models provide two distinct GPM ranges. And the outstanding distribution patterns of all MAGNUM UltraMAX nozzles make them excel in high demand areas like greens/tees, infield conditioning and equipment and stadium washdowns.

TURBO SHIFT

Dual Variable Flow: Delivers light fog and low volume jet stream patterns before shifting to high volume jet stream and fan patterns.

High Flow Model:
Opens with 12-17 GPM (45-64 L/min)
Turbo Shifts to 20-43 GPM (76-163 L/min)
Super High Flow Model:
34-104 GPM (129-394 L/min)

features / specifications

- Multi-Pattern Spray: Fog, Jet Stream, Fan
- Built for 1" NPSH and 3/4" Hose Flow Rates (range: 7-43 GPM)
- Nozzles and Valves rated at 600 psi working pressure



FULL THROTTLE

Single Variable Flow: Delivers steady, maximum volume fog, jet stream and fan patterns.

High Flow Model: 15-40 GPM (57-151 L/min)

Super High Flow Model:
39-100 GPM (148-379 L/min)

SCAN
to learn more!

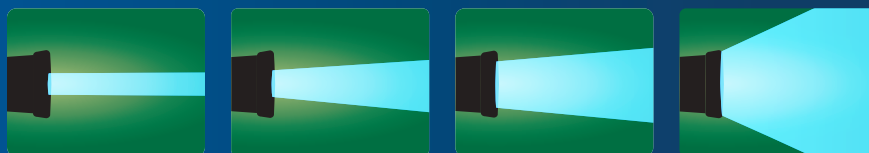

Variable sprays for any application

ordering PREMIUM PLUS PRO - All flow rates based on 80 psi (5,5 bar)

High Flow	Part # NG550-DFH-75	Turbo Shift 12-43 GPM (45-163 L/min) - 3/4" FHT inlet
	Part # NG550-DFH-10	Turbo Shift 12-43 GPM (45-163 L/min) - 1" FHT inlet
Super High Flow	Part # NG550-DFSH-10	Turbo Shift 34-104 GPM (129-394 L/min) - 1" FHT inlet
High Flow	Part # NG500-SFH-75	Full Throttle 15-40 GPM (57-151 L/min) - 3/4" FHT inlet
	Part # NG500-SFH-10	Full Throttle 15-40 GPM (57-151 L/min) - 1" FHT inlet
Super High Flow	Part # NG500-SFSH-10	Full Throttle 39-100 GPM (148-379 L/min) - 1" FHT inlet

Replacement Parts Part # NG5600-PKIT Repair Kit for Magnum UltraMax Nozzles

ordering PREMIUM PRO - All flow rates based on 80 psi (5,5 bar)

Part # NG650-DFH-75	Turbo Shift 12-43 GPM (45-163 L/min) - 3/4" FHT inlet
Part # NG650-DFH-10	Turbo Shift 12-43 GPM (45-163 L/min) - 1" FHT inlet
Part # NG600-SFH-75	Full Throttle 15-40 GPM (57-151 L/min) - 3/4" FHT inlet
Part # NG600-SFH-10	Full Throttle 15-40 GPM (57-151 L/min) - 1" FHT inlet

Magnum™ UltraMAX Premium PRO Series

MADE OF HIGH STRENGTH COMPOSITE MATERIAL, AIRCRAFT ALUMINUM AND TPR RUBBER



TURBO SHIFT

Dual Variable Flow: Delivers light fog and low volume jet stream patterns before shifting to high volume jet stream and fan patterns.

High Flow Model (only):
Opens with 12-17 GPM (45-64 L/min)
Turbo Shifts to 20-43 GPM (76-163 L/min)



FULL THROTTLE

Single Variable Flow: Delivers steady, maximum volume fog, jet stream and fan patterns.

High Flow Model (only):
15-40 GPM (57-151 L/min)



features / specifications

- Multi-Pattern Spray: Fog, Jet Stream, Fan
- Built for 1" NPSH and 3/4" Hose Flow Rates (range: 12-43 GPM)
- Nozzles and Valves rated at 600 psi working pressure

SCAN to learn more!



Same Performance for Half the Cost!

Magnum™ Stinger

THE ALL PRESSURE NOZZLE

The Magnum™ Stinger nozzle is an incredibly smooth operating nozzle, making it ideal for low pressure or low flow rate situations.

features

- Superior, picture perfect patterns when used with low pressure or low flow rates
- All metal construction gives you high performance, low volume patterns when used in high pressure situations
- Ergonomic design fits comfortably in your hand for easy operation



NEW!

ordering

Part # NG400	MAGNUM™ Stinger Nozzle
Part # NG450	MAGNUM™ Hose Nozzle
Part # HS-NG450	Hex screw for NG450
Part # OR-NG450	O-Ring for NG450
Part # RC-NG450	Retaining cap for NG450

Magnum™

SOLID METAL HOSE NOZZLE

Our Magnum™ nozzle is precision-machined with very smooth operation and outstanding distribution patterns make it ideal for high-demand areas like greens and tees. Magnum™ is also an excellent equipment wash-down nozzle.

features

- Solid metal internal - no plastic parts to break or wear out
- Multi-pattern sprays - effortless control with hydraulic assist on/off
- Ratchet mechanism prevents over-tightening damage
- Fire hose quality nozzle feels great in your hands
- Built for 1" and 3/4" flow rates

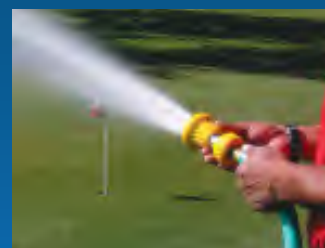

Variable Sprays for Any Application

Hose End Valves

PowerFLOW™ Series Control Valves

WORKS GREAT WITH ALL OUR NOZZLES
Heavy Duty Brass Construction Built to Last!

features

- Heavy Duty Brass Valve with Brass Shut-Off Lever
- Full Flow Rates Allow Up to 48 Gpm (on 1-Inch Model), Higher Than Any Other Control Valve
- Easily Control Water Flow with Nothing More Than Your Thumb
- 1-inch NPSH or ¾-inch GHT Threads



Also available in ¾" Shut-Off Valve

Extra Large Opening for High Flow Operation compared to competitor



PowerFLOW Series

CoolPro™

**COOL WITHOUT OVER WATERING
- NO ROOT DAMAGE**

A hot summer day can be murder on your greens. Use too much water and you risk damage to the roots. CoolPro™ is the first nozzle specifically designed for the single purpose of lightly misting the turf canopy to cool without over watering. And its 25 foot fogging pattern gets the job done quickly.

features

- Precision™ Nozzle Fogs at 70 PSI to Deliver a 25 ft. Pattern with Only 4-6 GPM
- ¾" Inlet (1" Brass Adapter Available)
- Ergonomic Handle/Valve Provides Easy Grip and Variable On/Off Control
- Durable Solid Metal Design



Perfect for tournament play, CoolPro™ puts down only enough water to cool the turf canopy. It prevents wilting while maintaining good ball speed.



ordering

- | | |
|---------------|--|
| Part # CV10H | Brass PowerFLOW Control Valve; 1" NPSH |
| Part # CV075H | Brass High-Flow ¾" Shut Off Valve |
| Part # HNC075 | CoolPro™ Valve and Nozzle |
| Part # HN0600 | CoolPro™ Nozzle only |
| Part # CV075L | CoolPro™ Valve only |

Hose Tap Splitters / Valves

Power-Splitter™ 2-Way Hose Tap Splitter

¾" ALL BRASS 2 WAY HOSE TAP / VALVE
Heavy Duty Brass Construction Built to Last!

features

- Finally the High Quality, High Flow Hose Splitter You've Been Waiting for
- Large Brass Ergonomic Handles For Easy Flow Control
- Larger Ports Allow for Full Flow Rates Over 30 GPM
- All Brass & Stainless Steel Construction for Ultimate Durability



Our Port



Their Port



PowerFLOW Series

Hose Tap Splitters for Easy ON/OFF Water Use!

Hose Tap / Valves

¾" BRASS 2 & 4 WAY HOSE TAP / VALVES

features

- Heavy Duty Brass Construction
- Angled Outlets for Easy Hose Attachment
- Comfort On/Off Levers



Super High-Flow Control Valve

WORKS GREAT WITH ALL OUR NOZZLES

Composite Plastic/Steel Construction Built to Last!

features

- ¾" FHT x ¾" MHT
- Made of Composite Plastic/Steel
- Heavy-Duty Construction – Made to Last
- High Flow Operation
- Oversized Handle For Easy On/Off



*Hose End Valves for
Easy ON/OFF Spraying*

ordering

Part # A-HB2HF	2-Way Hose Splitter, PowerFLOW Model
Part # A-HB2	¾" 2-Way Hose Tap/Valve
Part # A-HB4	¾" 4-Way Hose Tap/Valve
Part # A-BV77FM	High-Flow ¾" Composite/Steel Valve

PowerBlast™ BRASS Nozzle Series

PowerBlast™ Super Sweeper **NEW!**

SOLID BRASS SWEEPER NOZZLE

Heavy duty solid machined brass construction nozzles built to perform and last. Low flow designed to save water yet produce high power jet output. Ideal for equipment power wash down, cleaning driveways and walkways with minimum water usage - 7 GPM at 80 psi.

features

- Solid Machined Brass Construction
- Constant Flow Smooth Operation
- Simple Reliable Long Life



MultiMax Adjustable Nozzle 4"

SOLID BRASS ADJUSTABLE NOZZLE

High Pressure Easy Twist variable pattern nozzle, no leak design fine mist to power jet spray adjustment 5 GPM at 80 psi.



Sweeper 2" Power Nozzle

SOLID BRASS SWEEPER NOZZLE

High Pressure nozzle, no leak design with power jet spray. Ideal for equipment power wash down, cleaning driveways and walkways with minimum water usage.



ordering

- | | |
|---------------|--|
| Part # SN6-75 | Super Sweeper 6" Power Nozzle- $\frac{3}{4}$ " GHT Inlet |
| Part # SN2-75 | Sweeper 2" Power Nozzle - $\frac{3}{4}$ " GHT Inlet |
| Part # GNA-75 | MultiMax Adjustable Nozzle - $\frac{3}{4}$ " GHT Inlet |

DrainBlaster™

HIGH PRESSURE DRAIN CLEANING NOZZLE

This unique hose-end, high pressure nozzle guides itself in cleaning out drains, to remove debris with ease. Special feature includes a wire attachment connector for using wire locator to determine drain route.

features

- Front jet cuts through blockage
- Minimum water pressure: 70 psi
- Rear jets propel nozzle upline
- Heat treated grade 303 Stainless Steel for long life
- Two stage flushing action
- Great for sleeving under sidewalks or cart paths



Ideal for 4" - 6" drains and catch basins



Perfect for sleeving under sidewalks

Wire attachment connector for mapping drain location under greens, bunkers and other locations using a wire locator.

SCAN
to learn more!



RainPro™ SOLID METAL SHOWER NOZZLE

This revolutionary nozzle puts out a whopping 40+ GPM with a soft pattern that allows you to flood infield skin without conditioner moving or soak new sod without any damage to the turf. It's soft and gentle pattern is also perfect for landscape or flowers.

features

- Ultra durable construction withstands any abuse
- Beautiful, consistent and uniform spray pattern
- Materials: Zinc Alloy, Brass and TPR rubber
- Flow: 40 GPM @ 80 psi (built for 1" and ¾" hose flow rates)
- Nozzle assembly unscrews for easy cleaning

*Gentle Rain Shower Head
Perfect for Turf / Landscape*



ordering

- | | |
|---------------|---|
| Part # DN-75 | DrainBlaster™ Nozzle - ¾" GHT Inlet |
| Part # DN-10 | DrainBlaster™ Nozzle - 1" NPSH Inlet |
| Part # SHN-75 | RainPro™ Shower Nozzle - ¾" or 1" Inlet (includes ¾" Adapter Part# A-BA107MF) |

Precision™ Nozzle Kits



precision watering
for specific tasks

SOLID METAL, SPECIFIC TASK HOSE NOZZLES

Underhill® Precision™ nozzles deliver millions of soft, uniform droplets to provide rapid yet surprisingly gentle water application over a huge range of flow rates. From soft watering to powerful drenching, patented Precision nozzles are designed with ideal flow rates and droplet sizes to fully irrigate without disturbing turf, dirt, seeds, etc., providing a precise solution for every hand watering application.



- CoolPro™ TASKS:** Greens, tees, seed beds, transplants, delicate landscaping (4-6 GPM)
Rainbow™ TASKS: Greens, tees, seed beds, transplants, delicate landscaping (15 GPM)
Rainmaker™ TASKS: Syringe and spot watering turf and hardy landscaping (23 GPM)
Cloudburst™ TASKS: Dry spots, drenching, and wetting agent application (35+ GPM)
Cyclone™ TASKS: Pre-game skins watering, heavy watering of large areas, ideal for hydroseeding (50+ GPM)

Note: GPM will vary with pressure at nozzle

SCAN to learn more!



Nozzle Kits include brass High Flow Control Valve and 3/4" MHT x 1" FHT Adapter.

To order nozzle only: remove "CV" from part number.



ordering

- | | |
|-----------------|--|
| Part # HN0600CV | Precision™ CoolPro™ Nozzle Kit |
| Part # HN1500CV | Precision™ Rainbow™ Nozzle Kit |
| Part # HN2300CV | Precision™ Rainmaker™ Nozzle Kit |
| Part # HN4800CV | Precision™ Cloudburst™ Nozzle Kit |
| Part # HN5000CV | Precision™ Cyclone™ Nozzle Kit |



NozzleLocker™

THE VERY BEST NOZZLES - KEEP THEM SECURE

Nozzle kit includes:

- Full Precision™ Nozzle Series
- Solid Brass High-Flow Valve
- CoolPro™ with Precision™ Fogging Nozzle
- Your choice of MAGNUM™ Multi-pattern Nozzle
- Unbreakable, lockable, corrosion-proof Pelican case to keep these tools safe and secure

NEW!



ordering (all kits include secure Pelican case as shown)

- | | |
|----------------|--|
| Part # HP-K1 | NozzleLocker™ with 3/4" Magnum (yellow) nozzle |
| Part # HP-K2 | NozzleLocker™ with 3/4" Magnum UltraMAX Full Throttle nozzle |
| Part # HP-K3 | NozzleLocker™ with 3/4" Magnum UltraMAX Turbo Shift nozzle |
| Part # HP-K4 | NozzleLocker™ with 1" Magnum UltraMAX Full Throttle nozzle |
| Part # HP-K5 | NozzleLocker™ with 1" Magnum UltraMAX Turbo Shift nozzle |
| Part # HP-B075 | Baseball NozzleLocker™ - 3/4" Kit, includes Magnum NG450, SN6-75 Sweeper, HN5000 & HN1500 Nozzles, CV-075H control valve, (2) Twist-Ease 3/4" |
| Part # HP-B100 | Baseball NozzleLocker™ - 1" Kit, Includes Magnum UltraMax NG550 Nozzle, SN6-75 Sweeper, HN5000 & HN1500 Nozzles, CV10H control valve, A-BA107FM and A-BA107MF adapters, and (2) 1" Twist-East Kink Eliminators |

Baseball kit includes:

- Fire Nozzle for skins
- Precision 15 GPM nozzle for mound, baselines, and batters box
- Precision 50 GPM nozzle for skins
- High flow brass control valve
- Twist-Ease Hose Kink Eliminator (qty 2)
- Sweeper Nozzle for lip blasting
- Adapters for 1 inch or 3/4 inch applications inside secure Pelican case

Solid Brass Adapters

Power>Connects™

POWER>CONNECTS FROM UNDERHILL ARE THE EASIEST WAY TO SWITCH AROUND NOZZLES OR DISCONNECT YOUR HOSE FROM THE SOURCE.

With a simple twist, your nozzle is locked in place without any loss of flow rate or leaking.

features:

- The Easiest to Use Quick Connect Fittings for Your Hose and Nozzle
- Full Port Openings Provide Maximum Flow Rates
- Leak Free Connections Hold Even with High Pressure
- Great Add On to Our Brass Control Valves (pg. 16)
- Available in 3/4" GHT or 1-inch NPSH



ordering

Part # A-BQ7M	3/4" Brass Power>Connects, Male end
Part # A-BQ7F	3/4" Brass Power>Connects, Female end
Part # A-BQ10M	1" Brass Power>Connects, Male end
Part # A-BQ10F	1" Brass Power>Connects, Female end

Quick Connects™

BRASS QUICK CONNECTS FROM UNDERHILL ARE A FAST WAY TO SWITCH AROUND NOZZLES OR DISCONNECT YOUR HOSE FROM THE SOURCE.

Our Proline Quick connects are an easy and affordable way to quickly connect and disconnect a nozzle or hose.

- Comes in a Set of Both Male and Female Ends
- 3/4" GHT



3/4" Quick Connect
Inlet/Outlet M/F GHT

Hose Thread Reducers

Convert Hoses and Nozzles Between 1-inch NPSH and 3/4" GHT

- Made of High Quality Brass with Heavy Duty Rubber O-Rings



Part # A-BA107FM



Part # A-BA107MF

Pipe to Hose Thread Adapters



Part # A-BA10NXSH
1-inch FPT x 1-inch Male NPSH

- High Quality Brass



Part # A-BN107MM
1-inch MPT x 3/4" Male GHT

- High Quality Brass

**Solid Brass Construction
For Long Lasting Use!**

ordering

Part # A-QC075	3/4" Quick-Connect, M/F GHT - Brass
Part # A-BA107FM	1" FHT x 3/4" MHT Brass Hose Adapter
Part # A-BA107MF	1" MHT x 3/4" FHT Brass Hose Adapter
Part # A-BA10NXSH	1" FPT x 1" Male NPSH Brass Hose Adapter
Part # A-BN107MM	1" MPT x 3/4" MHT Brass Hose Adapter
Part # HN075W	10 pack of 3/4" Hose Washers
Part # HN100W	10 pack of 1" Hose Washers

Hose Washers



Part # HN075W
Part # HN100W

DeepDrip™

TREE WATERING STAKES

Water and fertilize your trees at the roots, encouraging deeper roots and healthier trees with DeepDrip™ stakes. Water gets underground fast, so you can irrigate for shorter periods and save water. They also help aerate the soil, and you can add fertilizer into the shaft to direct nutrients to the root zone.

Three Lengths For All Tree Sizes: Use the 14.5" stake for shallow root trees and shrubs, like rose bushes and ornamental trees (or boxed trees). The 24.5" stake is best for most other tree varieties except for palms and similarly deeper rooted trees, which will benefit from the longer 36" stakes.

Built Smart - And Easy To Use: The DeepDrip's reinforced tip and cap are made from ABS and the upper shaft is made from Schedule 40 PVC. Multiple holes in the bottom half of the spike, internally covered by a mesh filter, allow water to flow out but keep dirt from getting in and clogging the tube. The UV-protected cap acts as a reinforced cover when pounding the stake into the ground, keeps debris from entering the shaft and holds a 1/4" drip line/emitter securely in place. By inserting a screwdriver through the two holes at the top of the upper shaft, stakes can be easily pulled up to remove/reposition, or rotated to deter root invasion.

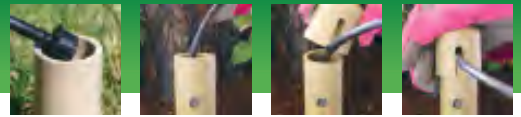

ADD TO EXISTING TREES! Install DeepDrip™ stakes during or after tree planting for instant access to the root system for fertilizer delivery or to set up deep automatic drip watering.



ordering

Part # A-DD08	DeepDrip™ 8" watering stake
Part # A-DD14	DeepDrip™ 14.5" watering stake
Part # A-DD24	DeepDrip™ 24.5" watering stake
Part # A-DD36	DeepDrip™ 36" watering stake

EasyOUT™ 2in1

SPRINKLER REMOVAL TOOL FOR ROTORS & SPRAY HEADS

Fits Major Rotors (3/4" inlet) & Spray Head (1/2" inlet)

Remove & Replace

Heads in 3 minutes or less

- No Digging
- No Damage to Turf
- Saves Time and Money

SCAN to learn more!



STEP 1



- Remove cap and inside components
- Insert telescopic rod to desired length into sprinkler body & fitting

STEP 2



- Place tool over rod and inside sprinkler body
- Rotate tool counter clockwise to remove body

STEP 3

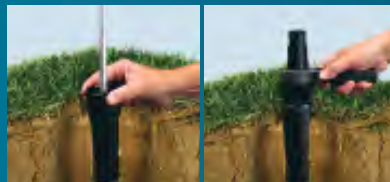

- Place new sprinkler body over rod and into ground
- Push down and rotate tool clockwise to connect sprinkler body to pipe and remove rod

STEP 4



- Replace new sprinkler components and cap

SPECIAL ASSIST TORQUE WRENCH

ordering

Part #: A-E0-SRT-RS
EasyOut™ 2in1
Sprinkler Removal
Tool

Part #: A-E0-05EC
EasyCap™
1/2" female
FPT fitting

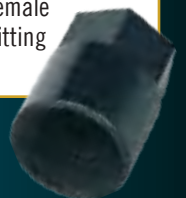

VersaLid™ Universal Replacement Lids

VersaLid™ **NEW!**

VALVE BOX UNIVERSAL REPLACEMENT LIDS

VersaLid™ is the easy solution for broken or missing valve box lids. No need to guess what brand a buried box is or even worse - dig it up to find out - VersaLid's locking system fits all round valve boxes. New sizes in 10 inch and 6 inch and three colors available – Green, Purple, Tan



features

- One lid fits all major brands of valve boxes including NDS, Carson, RainBird
- No need to replace the entire box or try to determine what brand box you have in the ground
- Our durable construction is stronger than OEM lids
- Two sizes available to fit most common round valve boxes - 10 inch and 6 inch

STRONGER! BETTER FIT!
than original equipment lids



Purple for Reclaimed Water & NEW! Tan for Desertscape



10" valve box lids available in 3 colors

6" valve box lids
available in 3 colors



ordering

Part # VL-6	Green VersaLid™ 6"-7" valve box lid
Part # VL-6P	Purple VersaLid™ 6"-7" valve box lid
Part # VL-6T	Tan VersaLid™ 6"-7" valve box lid
Part # VL-10	Green VersaLid™ 10" valve box lid
Part # VL-10P	Purple VersaLid™ 10" valve box lid
Part # VL-10T	Tan VersaLid™ 10" valve box lid

*Our Durable Construction
is stronger than OEM Lids*

HoseTap™



SOLID METAL HOSE ADAPTER

HoseTap™ gives you a hose connection anywhere you have a TORO® or RAIN BIRD® electric, valve-in-head sprinkler... a fast connection when quick-couplers or hose bibs are not available. Includes aircraft aluminum body (won't break or wear out like plastic) anodized with sprinkler manufacturer color, O-ring, riser, 1" Brass swivel and 3/4" adapter.

Also available without brass swivel or adapter.

features

- Use to plug wet heads into a block system



REPLACEMENT O-RINGS

- Part # OR-100 Fits TORO® 1" inlet and RAIN BIRD® Eagle 700 Series golf sprinklers / HoseTap
- Part # OR-150 Fits TORO® 1½" inlet golf sprinklers / HoseTap
- Part # OR-150R Fits RAIN BIRD® 1½" inlet golf sprinklers / HoseTap

HoseTap™ with 1" swivel & adapter

ordering

- Part # HN-T100S HoseTap™ for TORO® 1" inlet golf sprinklers
- Part # HN-T150S HoseTap™ for TORO® 1½" inlet golf sprinklers
- Part # HN-R125S HoseTap™ for RAIN BIRD® Eagle 700 Series sprinklers
- Part # HN-R150S HoseTap™ for RAIN BIRD® Eagle 900 Series sprinklers

Includes 1" brass swivel and 3/4" adapter.

HoseTap™ with 3/4" swivel

ordering

- Part # HN-T100-75 HoseTap™ for TORO® 1" inlet golf sprinklers
- Part # HN-T150-75 HoseTap™ for TORO® 1½" inlet golf sprinklers
- Part # HN-R125-75 HoseTap™ for RAIN BIRD® Eagle 700 Series sprinklers
- Part # HN-R150-75 HoseTap™ for RAIN BIRD® Eagle 900 Series sprinklers

Includes 3/4" brass swivel.

HoseTap™

ordering

- Part # HN-T100 HoseTap™ for TORO® 1" inlet golf sprinklers
- Part # HN-T150 HoseTap™ for TORO® 1½" inlet golf sprinklers
- Part # HN-R125 HoseTap™ for RAIN BIRD® Eagle 700 Series sprinklers
- Part # HN-R150 HoseTap™ for RAIN BIRD® Eagle 900 Series sprinklers

Does not include 1" brass swivel or adapter.



Splice Kit

3M DIRECT BURY SPLICE KIT

Each kit includes one wire connector which accommodates wire sizes from 18-10 gauge and a waterproof gel case. Excellent for golf, commercial and residential applications.

ordering

- Part # DBRY-4 Direct Bury Splice Kit - 4 Pack
- Part # DBRY Direct Bury Splice Kit - single unit

The EXTENDER™

STOP DIGGING, AND START EXTENDING!

No more handle scraping on the turf - a simple solution for low quick coupler valves which cause key handles to hit the turf around the valve box. Extend our Quick Coupler Keys an extra 4" - Save time from having to dig up and raise the valve to make the key operational.

features

- No More Handle Scraping on Turf
- Extend Quick Coupler Keys 4" Higher
- Solid Brass with Sturdy Built-in Handle



3 Models Available to Fit Any Key



Stops Key Handle From Scraping Turf



3/4" MPT x 1/2" FPT outlet
3/4" FPT inlet



1" MPT x 3/4" FPT outlet
1" FPT inlet



1 1/2" MPT x 1 1/4" FPT outlet
1 1/2" FPT inlet

Patent Pending

The Claw™

QUICK COUPLER MOTION RESTRAINT

When quick coupler valves become unscrewed from swing joints, it's more than just a hassle - it can be dangerous. The Claw™, new from Underhill®, offers a simple solution. Embedded in the soil below the quick coupler, and then securely attached to its base, The Claw provides significant resistance to rotational, vertical and horizontal motion, preventing the valve from moving. Made from high strength ductile iron, this compact anchor attaches easily with a single steel bolt.

EASY RETROFIT! Installs Without Removing Valve or Valve Box - Fits in 6" Round Box or Larger!

ordering

Part # QK-075EX	Extender - 3/4" MPT x 1/2" FPT outlet
Part # QK-075EX	Extender - 1" MPT x 3/4" FPT outlet
Part # QK-075EX	Extender - 1 1/2" MPT x 1 1/4" FPT outlet
Part # QCA-075100	The Claw™ for 3/4" and 1" valves
Part # QCA-150	The Claw™ for 1 1/2" valves

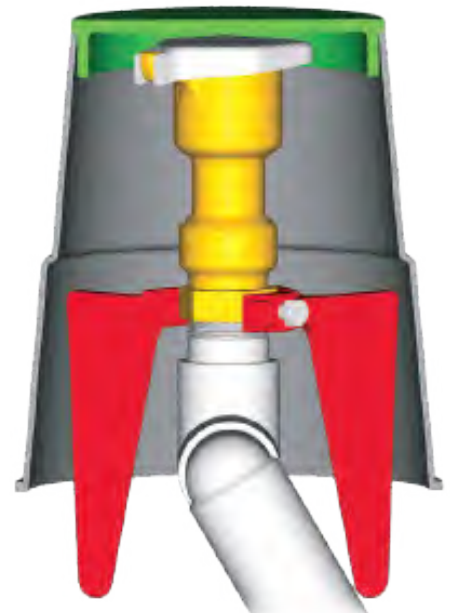

The Claw™ pictured with 1" quick coupler, key and hose swivel

Ultra Brass™ Gold Series Quick Coupler Keys

ULTRA BRASS KEYS ARE HEAVY DUTY SOLID BRASS WITH STAINLESS STEEL

Single Lug designed to fit Underhill Ultra Brass Quick Coupler QVS Series 1-Piece Valves, And QVD Series 2-Piece Valves, Also Compatible with Other Popular Valve Brands.
(See Cross Reference Chart Below)



QKS Series

- Red Brass
- Works with Both One Piece and Two Piece Quick Couplers
- Interchanges with Rain Bird, Toro, Hunter & Buckner
- Heavy Duty Galvanized Handles
- Stainless Steel, Single Lug on all models



Quick Coupler Key
1" MPT x 3/4" FPT outlet
Part # QK-100
1" MPT x 3/4" FPT outlet
Part # QK-125 (not shown)

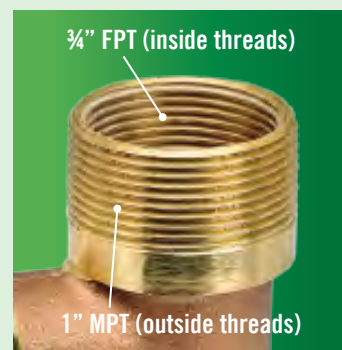

Quick Coupler Key
3/4" MPT x 1/2" FPT outlet
Part # QK-075

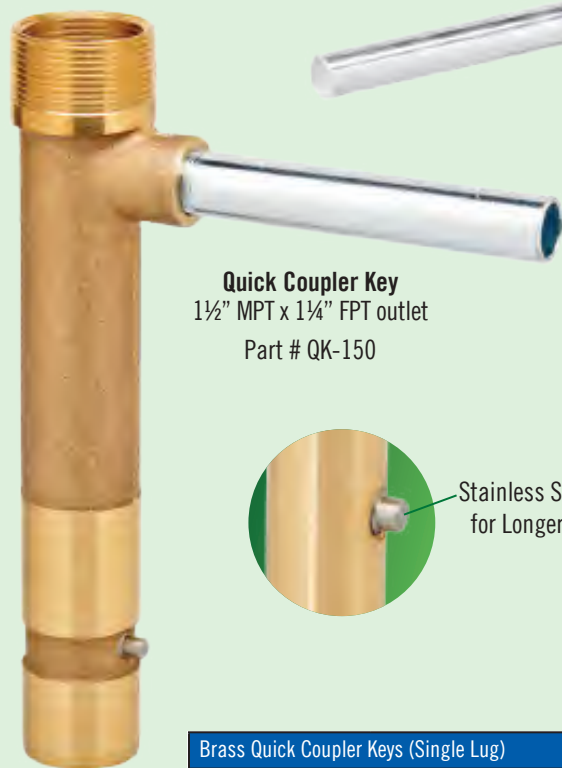

Quick Coupler Key
1 1/2" MPT x 1 1/4" FPT outlet
Part # QK-150

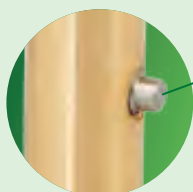

Stainless Steel Lugs for Longer Life



ACME threaded Key
1" MPT x 3/4" FPT outlet
Part # QK-100AT



ACME Threads

Brass Quick Coupler Keys (Single Lug)		Cross Reference Chart			
Underhill Model No.	Description	Buckner	Rain Bird	Toro	Hunter
QK-075	3/4" MPT x 1/2" FPT Key	Q33K07	33DK	463-01	N/A
QK-100	1" MPT x 3/4" FPT Key	QB44K10	44K	464-01	HK-44
QK-125	1" MPT x 3/4" FPT Key	QB5RK10	55K	465-01	N/A
QK-150	1 1/2" MPT x 1 1/4" FPT Key	N/A	N/A	N/A	N/A
QK-150RBTB	1 1/2" MPT x 1 1/4" FPT Key	QC151	7K	466-01	N/A
QK-100AT	1" MPT x 3/4" FPT ACME threaded Key	QB44KAT10	44KA	464-03	HK-44A

Ultra Brass™ *Gold Series* Quick Coupler Valves

DURABLE SOLID BRASS, SINGLE SLOT/LUG ESSENTIALS BUILT TO LAST.

Underhill Valves are Constructed of Solid Red Brass and Stainless Steel, with High Visibility Vinyl Covers, Our Valves Incorporate Rugged 1 and 2 Piece Design Options.

QVS Series

ONE PIECE BODY/SINGLE SLOT

- Red Brass
- Interchanges with Rain Bird, Toro, Hunter & Buckner
- Stainless Steel Accessories
- Spring Loaded Vinyl Covers

1-piece Valve
(¾" FPT inlet)
Part # QV-075R



1-piece Valve
(1" FPT inlet)
Part # QV-100R



1-piece Valve
(1½" FPT inlet)
Part # QV-150R



Cutaway of
2-Piece Valve



2-piece Valve
(1" FPT inlet)
Part # QV-100-2P



2-piece Valve
(¾" FPT inlet)
Part # QV-075-2P

QVD Series

TWO PIECE BODY/SINGLE SLOT

- Red Brass
- Interchanges with Rain Bird, Toro, Hunter & Buckner
- Stainless Steel Accessories
- Spring Loaded Vinyl Covers

Hose Swivels

- Part # HS-075 ¾" FPT x ¾" MHT outlet
 Part # HS-100 1" FPT x ¾" MHT outlet
 Part # HS-101 1" FPT x 1" MHT outlet
 Part # HS-151 1½" FPT x 1" MHT outlet



Single Piece Body - Brass Quick Couplers		Cross Reference Chart			
Underhill Model No.	Description	Buckner	Rain Bird	Toro	Hunter
QV-075R	¾" Quick Coupler w/ Yellow Rubber Cover	QCV075R	3RC	473-01	N/A
QV-100R	1" Quick Coupler w/ Yellow Rubber Cover	QCV100R	33DRC	473-21	N/A
QV-150R	1 ½" Quick Coupler w/ Yellow Rubber Cover	QCV151R	N/A	476-01	N/A
Two-Piece Body - Brass Quick Couplers		Buckner	Rain Bird	Toro	Hunter
Underhill Model No.	Description				
QV-075-2P	¾" Quick Coupler w/ Yellow Rubber Cover	QB33RC07	N/A	N/A	N/A
QV-100-2P	1" Quick Coupler w/ Yellow Rubber Cover	QB44RC10	44-RC	100-2SLVC	HQ-44

Ultra Brass™ *Gold Series* Impact Sprinklers

Solid Brass, Ultra-Reliable Work Horses for Reliable, Trouble-Free, High-Performance Year after Year... You Can't Beat Our Proven Impact Drive Sprinklers. Designed with High Uniformity Nozzles, Available in Full Circle and Full/Part Circle Models Along with Additional Nozzle (Gpm/Radius) Options.

Full Circle Sprinklers

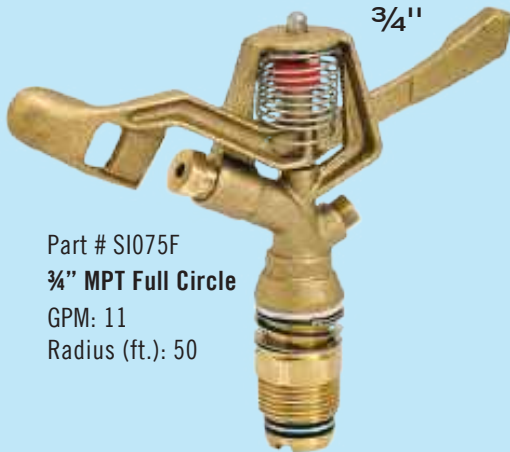

Part # SI075F
3/4" MPT Full Circle
 GPM: 11
 Radius (ft.): 50

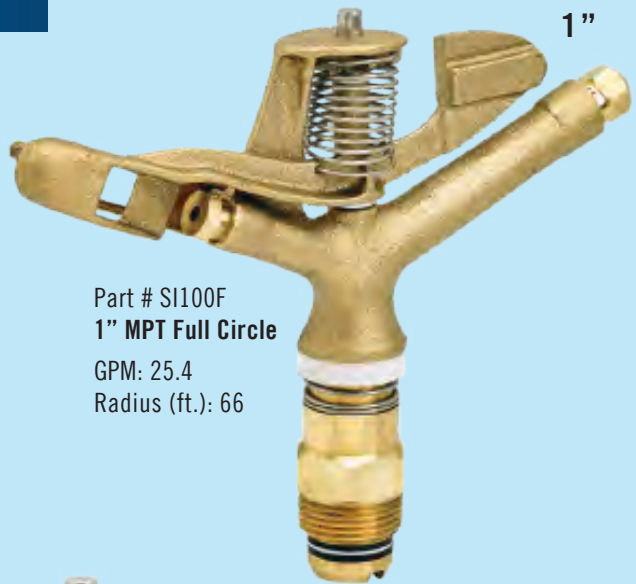

Part # SI100F
1" MPT Full Circle
 GPM: 25.4
 Radius (ft.): 66



Part # SI125F
1 1/4" MPT Full Circle
 GPM: 48.3
 Radius (ft.): 93

features

- Solid Brass Construction
- Stainless Steel Drive Spring
- Bearing Assemble Hood for longer wear life
- Chemical Resistance Bearing Seals
- Straight-Flow, Low Pressure Loss
- Standard Solid Brass Nozzle included

Performance data shown with standard nozzle set @ 80 psi

ordering	Full Circle	GPM	Radius (ft.)
Part # SI075F	3/4" MPT Full Circle	11	50
Part # SI100F	1" MPT Full Circle	25.4	66
Part # SI125F	1 1/4" MPT Full Circle	48.3	93

GPM and radius will vary with pressure at sprinkler

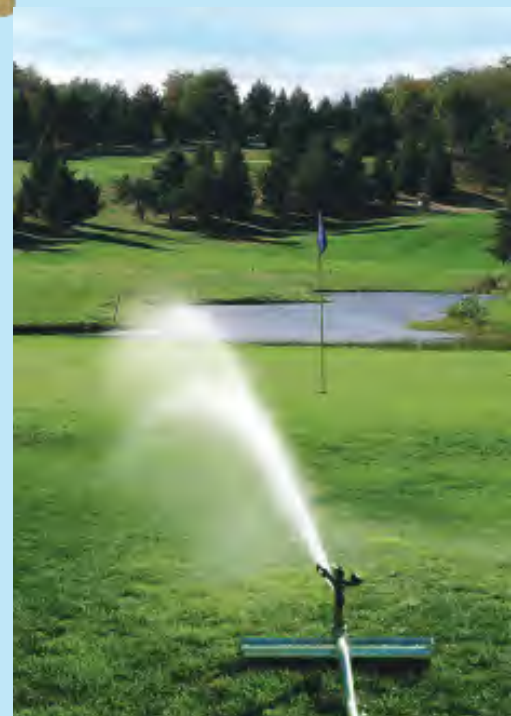

Ultra Brass™ *Gold Series* Impact Sprinklers

Part/Full Circle Sprinklers



Part # SI075P
 3/4" MPT Part/Full Circle
 GPM: 8.3
 Radius (ft.): 63

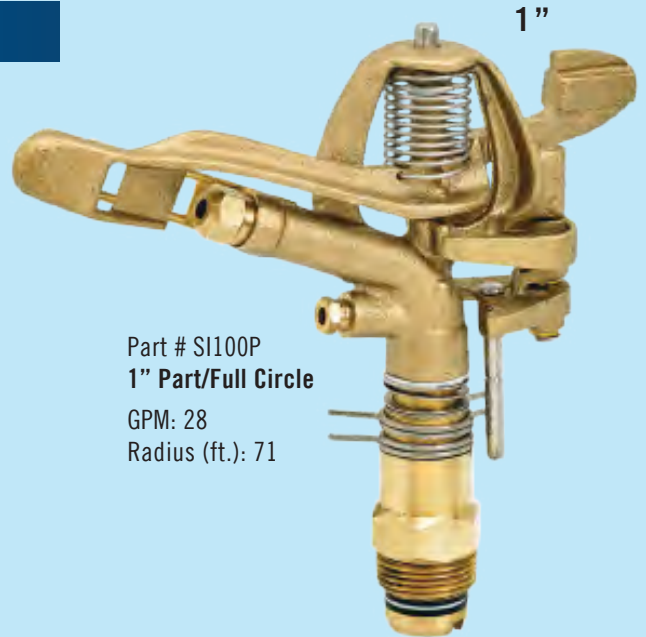

Part # SI100P
 1" MPT Part/Full Circle
 GPM: 28
 Radius (ft.): 71



Part # SI125P
 1 1/4" MPT Part/Full Circle
 GPM: 66
 Radius (ft.): 94



Underhill® Brass Impacts atop the RollerPro™ portable base puts a powerful sprinkler anywhere you can run a hose. (See page 28)

features

- Solid Brass Construction
- Stainless Steel Drive Spring
- Bearing Assemble Hood for longer wear life
- Chemical Resistance Bearing Seals
- Straight-Flow, Low Pressure Loss
- Standard Solid Brass Nozzle included

Performance data shown with standard nozzle set @ 80 psi

ordering	Part/Full Circle	GPM	Radius (ft.)
Part # SI075P	3/4" MPT Part/Full Circle	8.3	63
Part # SI100P	1" MPT Part/Full Circle	28	71
Part # SI125P	1 1/4" MPT Part/Full Circle	66	94

GPM and radius will vary with pressure at sprinkler



RollerPro™

PORTABLE SPRINKLER BASE

The 22" wide stainless steel roller of RollerPro™ provides a stable field position for supplemental watering. Designed for years of hard use, it is ideal for watering dry spots and newly seeded areas.

features

- 22" wide stainless steel roller is weighted to prevent movement during use
- ¾" inlet and outlet adapters included
- Standard 1" FHT inlet x 1" female NPT outlet

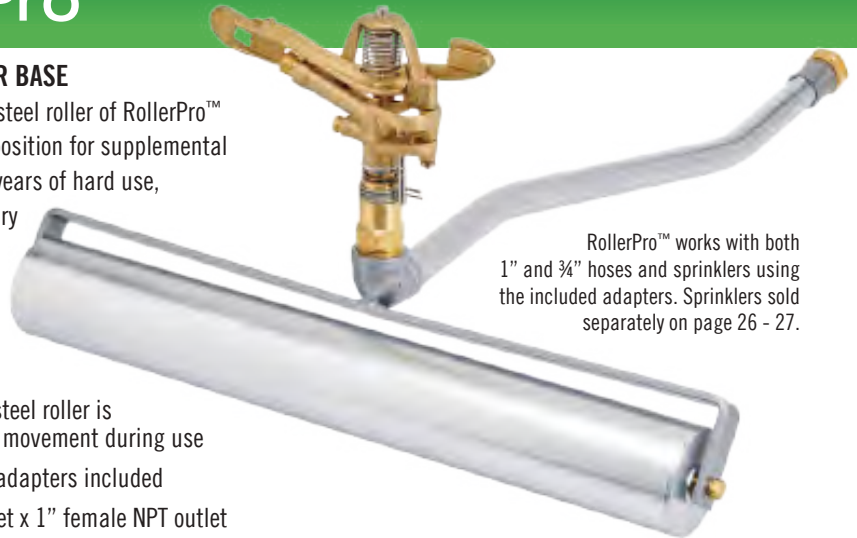

RollerPro™ works with both 1" and ¾" hoses and sprinklers using the included adapters. Sprinklers sold separately on page 26 - 27.



SpotShot™

LOW VOLUME PORTABLE SPRINKLER KIT

SpotShot™ is an expandable sprinkler system kit ideal for turf areas requiring low volume watering for extended periods. Connect the Starter Kit to a quick coupler (or golf sprinkler with the HoseTap™ on page 18) and connect Add-On Kits for larger area needs.

Starter Kit includes 20' of ½" flexible PVC tubing with connection fittings, pressure regulator, sprinkler base and low volume rotating sprinkler (20 ft. radius / 0.65 GPM - 0.16 in./hr.)

Add-On Kit includes 20' of ½" flexible PVC tubing with connection fittings, sprinkler base and low volume rotating sprinkler (20 ft. radius / 0.65 GPM - 0.16 in./hr.)

Micro-Sprinkler Options

- 20 ft. radius / 0.65 GPM (0.16 in./hr.)
- 20 ft. radius / 1.2 GPM - (0.26 in./hr.)

ideal for

- Leaching salts on greens
- Targeting hot spots on fairways, roughs, etc.
- Mound watering
- New seed grown in
- Other low volume watering

ordering

Part # A-RP221	RollerPro™	Part # R75-HFM-40	Pressure Regulator (40 psi)
Part # SS-SK	SpotShot™ Starter Kit (20 ft. rad, 0.65 GPM)	Part # TP-050-20	20' Coil of ½" PVC, SuperFlex Pipe
Part # SS-AOK	SpotShot™ Add-on Kit (20 ft. rad, 0.65 GPM)	Part # S40-050-HFS	¾" Hose Thread Female x Male, Slip Fitting
Part # SS-SK26	SpotShot™ Starter Kit (20 ft. rad, 1.2 GPM)	Part # S40-050-HMS	¾" Hose Thread Male x Female, Slip Fitting
Part # SS-AOK26	SpotShot™ Add-on Kit (20 ft. rad, 1.2 GPM)	Part # SS-S16	Micro-sprinkler (20 ft. rad, 0.65 GPM - 0.16 in/hr)
Part # SS-SB	SpotShot™ Sprinkler Base	Part # SS-S26	Micro-sprinkler (20 ft. rad, 1.2 GPM - 0.26 in/hr)

SuperKey XL™

MULTI-PURPOSE TOOL FOR TORO, RAINBIRD GOLF SPRINKLERS

The ultimate all-in-one tool for your golf sprinklers... think of it as a Swiss army knife, a must have companion. Made of stainless steel and composite material, it effortlessly turns electric valve-in-heads on and off, removes internal snap rings and performs many other sprinkler maintenance chores. Great for John Deere®/Signature® sprinklers, too!

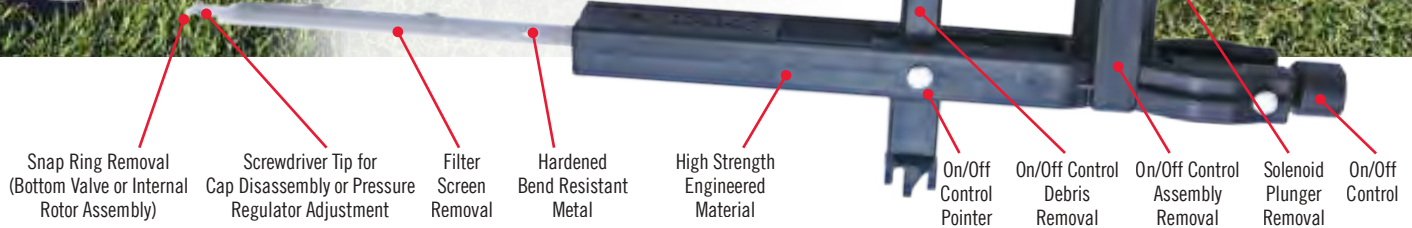

EasyReach™ Key

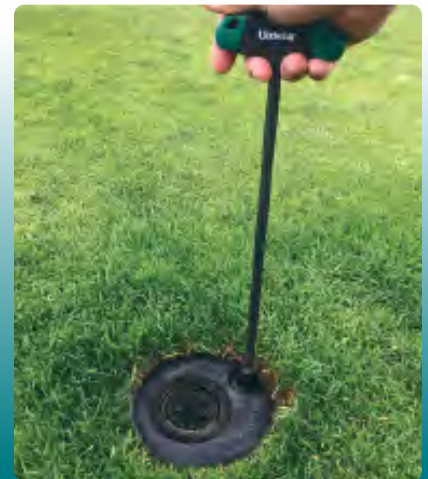

EXTRA-LONG SHAFT ON/OFF KEY

Extra long and extra heavy duty metal key designed for easy On/Off operation for TORO, Rain Bird and John Deere/Signature electric valve-in-head golf sprinklers. Made of high grade metal, EasyReach offers years of effortless on/off operation.

DOUBLE-Header™

SELECTOR VALVE KEY TOOL

The Double-Header™ On/Off Key for RainBird, Toro or John Deere/Signature irrigation heads conveniently mounted on a key ring.

features

- Extra clean-out tool for clearing around selector valve or makes a great snap ring tool in a pinch
- Never lose a flag key again with this mounted on your key chain
- Put one on all utility vehicle or equipment key rings so there is always a key for quickly turning off a stuck head or hitting a dry spot with water
- Sold in a package of 9 keys with key rings included

GREAT FOR:
TORO, RAINBIRD
and MORE

ordering

Part # A-SKTRB	SuperKey™ XL for Toro®, Rain Bird® and John Deere® golf sprinklers
Part # A-ERT	EasyReach™ for Toro® and John Deere®/Signature golf sprinklers
Part # A-ERR	EasyReach™ for Rain Bird® golf sprinklers
Part # A-DH	Double-Header™ Selector Valve Key Tool (9 Tools/pack)



POWERTM GULP

PROFESSIONAL WATER REMOVAL PUMP

POWER UP YOUR PUMPING GAME!

We've taken our premium Gulp Pro line to the next level with our new POWERGulpTM. Pumping just got so much easier with the flip of a switch and the ability to pump 11 GPM even in the dirtiest of water.

Features & Benefits

- Interchangeable battery plates sold separately to work with major brand batteries (Milwaukee®, DeWalt®, Makita® or Bosch®)
- Discharge can be either Gulp tubing, 3/4 inch hose or 1 inch hose (adapters included)
- Industry leading MudGuardTM filters out debris in the dirtiest of water allowing clog free suction
- The only pump that works well in dirty water
- Battery lasts up to 60 minutes per charge and pumps 11 GPM

Pump Specifications

- Flow Rate - 11 GPM
- Length - 48"
- Weight - 4 lbs (without battery)
- Battery Run Time - Up to 60 Minutes w/ 4 Amp Hr. Battery
- Head Height - 15 ft
- Not For Use on Flammable Liquids
- 18 Volt



Recommended Use For:



Irrigation Repairs

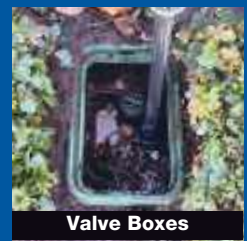

Valve Boxes



Catch Basins



Golf Courses
and Landscape

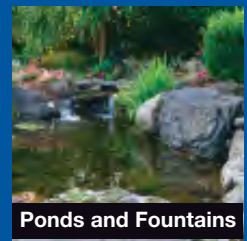

Ponds and Fountains

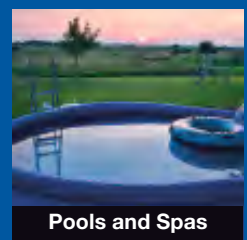

Pools and Spas

POWERGulpTM

Part # A-PG-18V

PUMP PARTS & ACCESSORIES

POWER GULP™

Battery Adapter Plates

WHY PURCHASE ANOTHER BRAND OF BATTERY AND CHARGER WHEN YOU CAN USE YOUR CURRENT BRAND BATTERIES WITH THE UNDERHILL® POWERGULP™.

Simply purchase the correct adapter plate for your 18-20V slide-style battery and install on the PowerGulp with four easy screws.

- Interchangeable battery adapter plates available for Milwaukee®, DeWalt®, Makita® and Bosch®



Underhill® Battery & Charger

Don't have another brand already? No problem, just use the affordable Underhill® brand battery and charger and get your pump running immediately for 60 minutes of run time!

features

- 4 Amp Hr. 18 Volt battery
- Slides into stock plate on PowerGulp
- Battery only or Battery and Charger



POWERGulp™ Quick-Stand

Use this clamp-on stand to keep your pump upright and working without you holding it. (stand not pictured)

features

- Great for pumping out bunkers or mainline repairs
- Lightweight and detachable

ordering

Part # A-PG-18V	POWERGulp Professional Pump
Part # A-PG-APMI	Power Gulp Adapter Plate, Milwaukee®
Part # A-PG-APMA	Power Gulp Adapter Plate, Makita®
Part # A-PG-APDE	Power Gulp Adapter Plate, Dewalt®
Part # A-PG-APBO	Power Gulp Adapter Plate, Bosch®
Part # A-PG-BAT	Underhill® Battery only
Part # A-PG-BATCH	Underhill® Battery and Charger
Part # A-PG-QS	PowerGulp™ Quick-Stand

GULPTM PRO

PREMIUM WATER REMOVAL PUMPS

SUPER HIGH-CAPACITY WATER REMOVAL SUCTION PUMPS

Whether you need to remove water from sprinklers and valve boxes or other areas or devices, UltraMax Series Pumps are the ideal tools for the job.

unique features

- High Suction Power
- Self Priming
- Polycarbonate Clear Body
- Replacement Plunger

BIG GULP PRO PUMP

- 37 oz./stroke
- 36" pump chamber
- 72" outlet hose

36" with **72"**
length hose

Part # A-G3672CK

The ONLY pump that completely disassembles for easy cleaning!



MudGuardTM

- Built-in Filter minimizes clogging and makes pumping easier.
- A must have accessory for dirty water use
- Easy on and off for cleaning out debris



NEW & IMPROVED!

Omni-Directional



Intake Foot Valve

REMOVABLE
for Easy Cleaning

Sure-Fit Discharge
Hose Connector
Stays Intact!

Removable Head Assembly
for Easy Cleaning

High Grade
Discharge
Hose (72")

Heavy Duty Clear
Extra High Strength
Polycarbonate
Cylinder Body

Aircraft
Aluminum Grade
Pump Shaft

MudGuardTM is Patented: Pat No. US 11,247,155 B2

GULPTM PRO

PREMIUM WATER REMOVAL PUMPS



GULP PRO PUMP

- 19 oz./stroke
- 14" clear pump chamber
- 36" outlet hose

Part # A-G1236-C

22" with 36" length hose

GULP PRO SYRINGE

- 24 oz./stroke
- 12" pump chamber

Part # A-G12S-C

24" with 17" length tube



GULPTM PRO is also great for these applications:

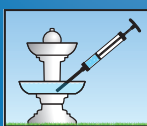

fountains

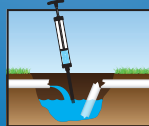

pipe repair

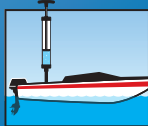

boats



toilets

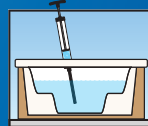

spas

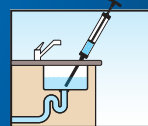

and more!

Replacement parts available



ordering

Part # A-G3672CK BIG GULP PRO Pump w/ 72" Outlet Hose

Part # A-G1236-C GULP PRO Pump w/ 36" Outlet Hose

Part # A-G12S-C GULP PRO Syringe

Part # A-GRPBV GULP PRO Bottom Valve

Part # A-GMG2 GULP PRO MudGuard

Part # A-GRPD GULP PRO Diaphragm & Plunger (2)

Part # A-GRPTE GULP PRO Top Elbow

Part # A-GRPSD GULP PRO Syringe Diaphragm & Plunger (2)

Part # A-GTUB-C2 GULP PRO Outlet hose - 100ft. Roll

EARLY STRESS DETECTION GLASSES

Disease, drought and weed invasion are plant and turf killers. But by the time you see them it can be too late. TurfSpy™ glasses, with stress detection technology developed by NASA, lets you “see into the future” to identify problems 2-10 days before they are visible to your naked eye. Keep your turf and vegetation healthy BEFORE serious problems arise.



fusarium patch

pythium blight

yellow patch (rhizoctonia)

brown patch

anthracnose

get a jump on broken or poor-performing sprinklers

highly efficient spot watering saves time and labor costs

superior weed location and spraying saves time and money

features

- Shatterproof/polycarbonate stress detection lens (ANSI approved safety lens)
- Wrap-around lens limits ambient light for optimal detection
- Sports frame with adjustable ear piece
- Lightweight case included

HOW IT WORKS

Dying vegetation absorbs and reflects sunlight differently than when it's healthy. The earliest signals occur at the outer limits of the human visual spectrum, and are rendered invisible compared to the predominant middle wavelengths. TurfSpy™ filters the light in the center so that fringe spectra, which show early plant stress, become visible.



ordering

Part # NG655-01 TurfSpy™ Glasses and Deluxe Case

Tracker™ 2

PORTABLE IRRIGATION MACHINE

The Tracker™ 2 offers an economical solution for supplementing seasonal watering needs of ¼ acre to 2 acre areas. It's also ideal for irrigating athletic fields, cemeteries, golf course roughs, or other large areas where an underground system is impractical. Built to last with precision German engineering and high quality materials, this portable powerhouse can irrigate an entire football field in just two passes.

Tracker™ 2 requires minimal labor to operate. Powered by water, it pulls itself along a steel cable, dragging up to 325 ft. of 1" reinforced heavy-duty hose (sold separately). Each pass irrigates about 2/3 acre per 8 hours of operations.

features

- Standard full/part circle sprinkler (11-13 GPM)
- 52 - 56 ft. radius
- Automatic shut-off at end of pass
- Water turbine drive and gear box
- 328 ft. steel cable
- Steel anchor stake
- Includes 1" brass Quick-Connect adapter
- Optional speed controller available



Precision German engineering and high quality components built to last!



specifications

- Weight: 81 lbs.
- Size: Length 33" Width 18", Height 22"
- Materials: Aluminum, Brass, ABS
- Minimum Operating Water Pressure: 50 psi
- Hose Required: 1"

ordering

Part # T-400-2 Tracker™ 2 Irrigation Machine
Part # R3SA-1019 Optional By-Pass-Kit for Speed Control

CatchCan **ULTRA**

FINALLY, AN IRRIGATION AUDITING CUP DESIGNED WITH FEATURES THAT GET THE JOB DONE RIGHT, QUICKLY AND ACCURATELY. PRECISE MEASUREMENTS OF SPRINKLER PERFORMANCE TO HELP MAXIMIZE WATER SAVINGS!

BUILT FOR THE PRO

- Easy To Read
- Easy To Transport

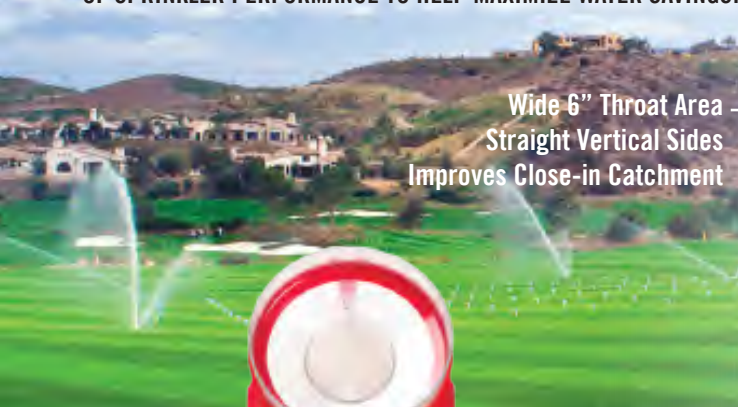

Wide 6" Throat Area
Straight Vertical Sides
Improves Close-in Catchment



Stable 3-Legged Stand
Easily Anchors in
Turf and Slopes

Tinted Cup for
Faster Reading

2 Piece Cup
& Stand
For Fast
Setup,
Teardown
and Storage

Large Inch & mL
Values for Fast
Data Collection

features

- Self standing - easily anchors into turf, even on slopes
- Measures sprinkler application in inches or centimeters
- Unique design allows for shorter duration test
- Made of durable polypropylene engineered plastic
- Can be stacked for easy storage and transport
- Each 12 Pack Kit (comes with instructions)

ordering

- | | |
|-----------------|--------------------------------------|
| Part # CCUPK-12 | CatchCan Ultra Cup & Stand - 12 Pack |
| Part # CCUC | CatchCan Ultra Replacement Cup |
| Part # CCUS | CatchCan Ultra Replacement Stand |

AuditMaster™

EXPERT SPRINKLER PERFORMANCE TESTING PRO KITS

Increasing watering times to compensate for poorly performing sprinklers wastes a lot of water. Accurately measuring sprinkler application rates with Underhill® AuditMaster™ helps maximize water savings.



4" x 5" Marking flags on 21" wire
(50 pack) are available in 6 colors

- | | |
|------------------|--------|
| Part # (50 pack) | |
| A-FLAG | Yellow |
| A-FLAG-B | Blue |
| A-FLAG-O | Orange |
| A-FLAG-P | Pink |
| A-FLAG-R | Red |
| A-FLAG-W | White |

ordering

- | | |
|-----------------|---|
| Part # AUD-LT | AUD-LT Pro Kit (Pictured): Includes 36 CatchCan Ultras, Pressure Checker with Gauge/Hose/Pitot Tube, Schrader Valve, Pressure Checker with Spray Head Adapter, Hose Bib Tap, Stop Watch, Anemometer Wind Gauge, 100 ft Measuring Tape, 50 Marking Flags, Wheeled Carry Case. |
| Part # SALESPO4 | AuditMaster Carry Case |
| Part # A-STW | Stop Watch |
| Part # A-WIND | Anemometer Wind Gauge |
| Part # MT-100 | Fiberglass Measuring Tape (100') |

Professional Water Pressure Gauges and Adapters

Dynamic Water Pressure Gauge

THIS IS THE IDEAL TOOL FOR CHECKING ACTUAL WORKING WATER PRESSURE VERSUS STATIC PRESSURE

There are many practical uses for this new specially designed gauge package. Pressure range up to 160 psi.

- Measures both **Dynamic** and **Static** pressure
- Solid Brass construction

ordering

Part # A-HPG-100 Hose end pressure gauge; includes: 1" Female x 1" Male hose connections; 160 psi gauge

Part # A-HPG-075 Hose end pressure gauge; includes: 3/4" Female x 3/4" Male hose connections; 160 psi gauge

Part # A-HPG-175 Hose end pressure gauge; includes: 1" Female x 3/4" Male hose connections; 160 psi gauge



Specialty Use Pressure Checkers

NOZZLE DISCHARGE PRESSURE GAUGES & ADAPTERS

Use these liquid-filled 160 psi gauge with 30" flex hose and solid brass Pitot tube, hose bib, or spray head and Schrader adapters to measure water pressure at discharge points.

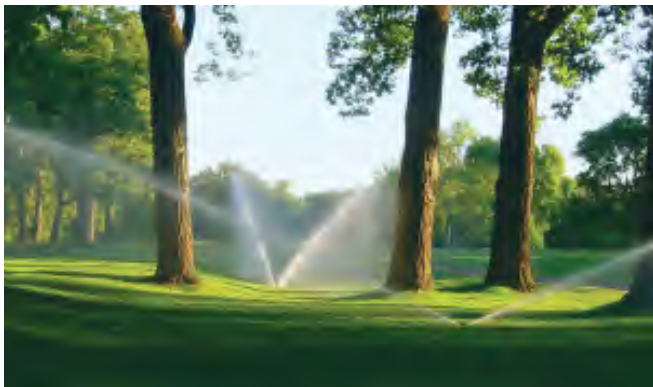

ordering

- Part # A-PHG-160K PressureChecker™, 30" Flex Hose, Pitot tube
- Part # A-HCGPK PressureChecker™ and Pitot tube
- Part # A-SV-160K PressureChecker™ with Schrader Valve Adapter
- Part # A-SHG-160K PressureChecker™ with Spray Head Adapter
- Part # A-HBG-160K PressureChecker™ with 3/4" POC Hose Bib tap
- Part # A-PG160L PressureChecker™ 160 PSI pressure gauge only
- Part # A-HCP Pitot tube only
- Part # A-HBT 3/4" Hose Thread x 1/4" Brass Hose Bib tap
- Part # A-SHA Spray Head Adapter

TURF TESTING

Soil Profiler/Shovel Type Sampler

Part # TSP-8x4

OUR ROBUST SOIL SAMPLER SLIGHTLY TAPERED TO GIVE A CLEAN CUT WITH MINIMAL TURF DISTURBANCE.

- Blade half is easily removed for examination of the soil profile, root depth & density.
- Produces a large flat sample 8" x 4"
- Plug can be replaced with minimum surface disturbance



Soil Sampler 2" Part # TSP-SS

ADJUSTABLE DEPTH GAUGE ALLOWS SOIL SAMPLER TO DOUBLE AS 2" PLUNGER REPAIR. BEST OPTION FOR USE ON SAND PROFILE AREAS OR ANY FINE TURF.

- Designed for use on well watered golf greens
- Open side barrel for easy inspection of soil structure
- Tee handle and hand grips for ease of use
- Hardened steel blade

Soil Probe Part # TSP-12

THE PERFECT TOOL WHERE DEEP SOIL SAMPLING IS REQUIRED. DESIGNED TO PENETRATE HARD SOIL.

- Open side 12" barrel for deep soil penetration and easy inspection of soil structure
- 12" extension bar
- Tee handle and hand grips for ease of use
- Hardened steel leading edge for optimum results



Handy Compact Sampler 3/4" Part # TSP-HS

DESIGNED FOR SMALL CORE SOIL SAMPLES, FAST SIMPLE AND ACCURATE.

- Triple window tine for quick and easy viewing of soil strata near the turf surface
- Lightweight Stainless Steel construction
- Plug size: 3/4" x 9 3/4"
- Removable "T" handle with convenient metal storage container



TURF REPAIR

Turf Doctor - Square Turf Repair 6" & 9"

PART # TTD-6 PART # TTD-9

THE IDEAL TOOL FOR FAST AND EXACT TURF SQUARE CUT AND REFIT. COMPLETE REPAIR CAN BE MADE WITH NO GAPS LEFT BETWEEN THE TURF.

- True surface level is maintained
- Plugs fit uniformly in every square hole
- Minimum root loss and quick turf recovery
- Zinc coded aluminum material, made to last

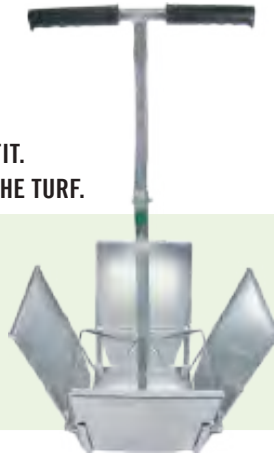

Round Plugger - Turf Repair/Soil Sampler 4" & 6"

Part # TRP-4 Part # TRP-6

FOOT OPERATED AND SPRING LOADED EJECTOR FOR QUICK TURF PLUG REMOVAL. IDEAL FOR EXTRACTING DISEASE SAMPLES AND REPAIRING DAMAGED TURF.

- Variable depth adjustment 1" - 4"
- Available in 4" & 5" round models
- 4" models ideal for extracting disease samples and turf repair
- 6" model great for damaged turf repair
- Thin blade is heat treated and zinc plated for clean cut

Round Plugger - Turf Repair/Soil Sampler 2"

Part # TRP-2

HAND PUSH OPERATED TURF PLUGGER/SAMPLER COLLECTS PLUGS IN TUBE STEM. IDEAL FOR SOIL SAMPLING AND DIVOT REPAIR ON GOLF GREENS.

- Variable depth adjustment ¼" - 4"
- Each plug is pushed up into tube as next plug is taken
- Plugger is zinc plated body and heat treated steel blade
- Solid steel construction for long life



3 Tine Aerator Part # T3TA-3

THE IDEAL TOOL FOR AERATING SMALL AREAS DUE TO COMPOSITION OR ADDING WATER PERCOLATION WHERE SOILS BECOME REPELLENT.

- Three ½" hollow tines
- Side-Eject hollow tines to prevent clogging
- Formed steel flat bar base with tubular "T" handle
- The choice of turf professionals for decades



LEVELING TOOLS

Level Lawn - Greens Keeper™ 30" - 36" - 40"

Part # TLLG-30K Part # TLLG-36K Part # TLLC-40K

GREENS KEEPER THE LIGHT WEIGHT OPTION IDEAL FOR SPREADING SCREENED TOPSOIL, SAND PEAT AND OTHER TOP DRESSING MATERIALS

- Industry standard for top dressing
- Features three open inner bars to catch small stones in the dressing
- Extra Heavy solid steel bars for extra rigidity (40" model)
- Super Heavy-Duty High Impact Resistant 72" Fiberglass Handle included

SCAN
to learn more!



Level Lawn Pull Master™ 72"

Part # TLLP-72

PULL MASTER IS THE TOP CHOICE FOR LEVELING OR SPREADING ON LARGE/FINE FLAT TURF AREAS

- Multiple Rope Hole Attachments Provided to Control Ground Pressure Options
- Rope with Handles Provided for 1 or 2 Man Operation
- Heavy Duty Solid Steel Construction, Made to Last
- Heavy Enough to Move Large Areas of Material, Compact Enough for Easy Storage
- Nylon Rope and Special Grip Handles Included
- Can also be pulled by a vehicle



turboTRIM™

PRO RATCHET SERIES
Patent pending

**Golf Sprinkler Head Trimming
Just Got Easier!**

**THE ONLY TRIMMER WITH A FORWARD &
REVERSE DRIVE RATCHET MECHANISM**

Finally, a unique tool designed and
engineered to help you do the job
like you never could before



Manual and Power Trimming Options >>

ordering

- Part # TTRT-100 Turbo Trim Tool, without cutting blade
- Part # TTRC-007 Turbo Trim 7" cutting blade
- Part # TTRC-008 Turbo Trim 8" cutting blade
- Part # TTRC-011 Turbo Trim 11" cutting blade

SCAN
to learn more!



Cutting Blades available in 3 sizes



PowerTRIM™

PRO SERIES

Patent pending

Trimming Golf Sprinkler Heads,
Fairway Yardage Markers
& Round Valve Boxes...

JUST GOT FASTER!

PowerTrim Cutting Blades -
Now with Longer Teeth for Quick
and Efficient Grass Trimming!



PowerTrim was Designed to Fit Most Major Straight Shaft Power Trimmer Brands

- Heavy Duty Steel Construction
- Easy to Install Blade
- Fast-Quality Trim, Cost Efficient Blade Design

7" Cutting Blades

TURBO TRIM Part # TTRC-007	Toro: 730, 760, 860, 830, 834S, DT 34/35, 835, 630	Rain Bird: 700, 751 (New Series)
POWER TRIM Part # PTC-007	Toro: 730, 760, 860, 830, 834S, DT 34/35, 835, 630	Rain Bird: 700, 751 (New Series)
6" Round Valve Boxes		

8" Cutting Blades

TURBO TRIM Part # TTRC-008	Toro: 670, 750, 780, 854, 855, 880DT 54/55, 650, Infinity Series	Rain Bird: E700, E750, 900, E950 (Newer Series)
POWER TRIM Part # PTC-008	Toro: 670, 750, 780, 854, 855, 880DT 54/55, 650, Infinity Series	Rain Bird: E700, E750, 900, E950 (Newer Series)
Hunter: 800, 900 Series		

11" Cutting Blades

TURBO TRIM Part # TTRC-011	Toro: 690	Kirby Fairway Markers, 9" & 10" Round Valve Boxes
POWER TRIM Part # PTC-011	Toro: 690	



*A Blade Adapter Kit For Your
Trimmer Brand Is Needed
To Mount Any Blade*

SCAN
to learn more!



Cutting Blades available in 3 sizes



ordering

- Part # PTC-007 Power Trim 7" Cutting Blade
Part # PTC-008 Power Trim 8" Cutting Blade
Part # PTC-011 Power Trim 11" Cutting Blade

Note: Power trimmer shown is not included.

Serious about saving water?



Profile™ nozzles for TORO®



730 SERIES	Full Circle: Front/Rear Nozzle Set		
Part #	Nozzle Color # range/spreader	Toro Noz #	
T730-3313	Brown 33 / Gray 13	33	
T730-3413	Blue 34 / Gray 13	34	
T730-3515	Violet 35 / Red 15	---	
T730-3515L (50 psi)	Green 35 / Red 15*	35	
T730-3615	Red 36 / Red 15*	36	
T730-3617	Red 36 / Lavender 17		

* For square spacing, specify #17 (lavender) nozzle with the #35 and #36 range nozzles



760 and 860 SERIES	Part Circle: Midrange/Close-in Nozzle Set		
Part #	Nozzle Color: midrange/close-in		
T760-GY	Gray / Yellow		
T860-GY	Gray / Yellow		



830, 834S, DT SERIES	Full Circle: Midrange/Close-in Nozzle Set		
Part #	Nozzle Color: midrange / close-in	Toro Series	
T830-GY	Gray / Yellow	830	
T834-GY	Gray / Yellow	834S	
TDT100-GY	Gray / Yellow	DT 34/35	



835S SERIES	Full Circle: Midrange/Close-in Nozzle Set		
Part #	Nozzle Color: midrange / close-in		
T835S-WP	White / Plug		

630 SERIES CALL FOR AVAILABILITY



670 SERIES CALL FOR AVAILABILITY



690 SERIES CALL FOR AVAILABILITY



750 SERIES	Full Circle: Front/Rear Nozzle Set		
Part #	Nozzle Color #range / spreader	Toro Nozzle #s	
T750-5617	Red 56 / Lavender 17	56	
T750-5717	Gray 57 / Lavender 17	57	



780, 880, 854S, DT SERIES	Midrange/Close-in Nozzle Set		
Part Circle (780), Full Circle (854S), Part/Full Circle (DT 54/55)			
Part #	Nozzle Color: midrange / close-in	Toro Series	
T780-BY	Black / Yellow	780, 880	
T880-BY	Black / Yellow	880	
T854-BY	Black / Yellow	854S, 880	
TDT150-BY	Black / Yellow	DT 54/55	



855S SERIES	Full Circle: Midrange/Close-in Nozzle Set		
Part #	Nozzle Color: midrange / close-in		
T855S-PP	Pink / Plug		

650 SERIES CALL FOR AVAILABILITY

Profile™ Solid Metal Golf Sprinkler Nozzles Ultra-High Uniformity

Upgrade your sprinklers with Profile™, the ultra-high uniformity, water conserving, solid metal nozzles from Underhill®.

before

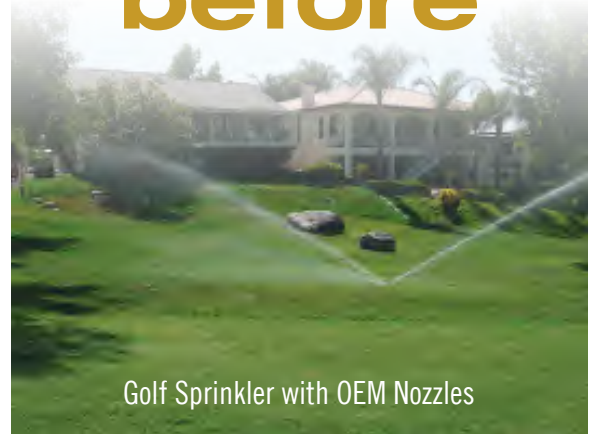

Golf Sprinkler with OEM Nozzles

August 14



Profile nozzles installed in problem area

**Use less water,
less energy and less
manpower and get
better course playability**

It's time to **replace** your nozzles!



You will see improved results immediately, save millions of gallons of water every year and improve the playability of your course at the same time...guaranteed.

after



Same Golf Sprinkler with Profile Nozzles

September 6



Uniform distribution restored, turf is green and healthy

SCAN
to learn more!



See how Superintendents are upgrading their entire golf courses!

Profile™ nozzles for Rain Bird®



EAGLE 700 SERIES

Full Circle: Midrange/Close-in Nozzles

Part #	Nozzle Color midrange / close-in	Rain Bird Nozzle #s
R70028-RG	White / Gray	28
R70032-RG	Red / Gray	32
R7003640-GG	Blue / Gray	36/40 and larger



Look familiar? Poor performing Eagle 700 sprinklers are often the result of clogged and worn nozzles. Profile nozzles' solid metal construction and nozzle shape were scientifically designed to solve this exact problem. They simply don't wear out. And they don't clog. Upgrade your old golf sprinklers to better than OEM with Profile!

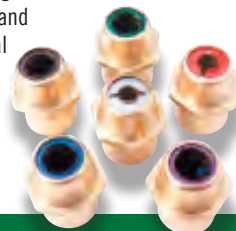

900 EAGLE SERIES

Full Circle: Close-in Nozzle

Part #	Nozzle Color
R900-M	Maroon



91 SERIES BRASS IMPACTS

Full Circle: Close-in Nozzle

Part #	Nozzle Color
R91-G	Gray



51 SERIES BRASS IMPACTS

Full Circle: Front/Rear Nozzles

Part #	Nozzle Color # range / spreader	Rain Bird Nozzle #s
R51-1411.5	White 14 / Gray 11.5	14 / 11.5
R51-1611.5	Blue 16 / Gray 11.5	16 / 11.5
R51-1811.5	Yellow 18 / Gray 11.5	18 / 11.5
R51-2011.5	Red 20 / Gray 11.5	20 / 11.5
R51-2213	Green 22 / Black 13	22 / 13
R51-2413	Black 24 / Black 13	24 / 13



All original equipment manufacturers, names and products presented in this publication are used for identification purposes only, and we are in no way implying that any of our products are original equipment parts. Toro® is a registered trademark of the Toro Company, Rain Bird® is a registered trademark of the Rain Bird Sprinkler Manufacturing Corporation.

PRO'S CHOICE WETTING AGENTS

The "Smart" Solution for Greens...
Tees, Fairways & Roughs too!

**Retains Water
in the Root Zone!**

Keeps Green Surface Firm and Playable

Tournament-Ready®

100% ACTIVE Ingredient

PREMIUM PENETRANT SOIL SURFACTANT

No Need to Water Until Evening Irrigation Cycles

45 Years of Research and Development in Pioneering
The Most Cost Efficient & Effective Option On The Market



What Makes Tournament-Ready® So Special?

3 Key Components utilizing Smart Surfactant Technology™

Component #1: Quick wetting penetration of soils, plus moves water out of water saturated soils.

How does it do it? Immediately relieves LDS and wets the soil profile where most competitive products will not wet the soil immediately and efficiently.

Component #2: Moves excess water out and keeps doing it.

How does it do it? Tournament-Ready will reduce the surface tension and attraction of water molecules to each other, making water "spread and infiltrate". The effect will increase the downward movement of excess water out of the root zone while decreasing the upward movement of capillary water in the soil. This will remove excess water from the 12" zone of a USGA or California style green.

Component #3: Holds water in the right place where it should.

How does it do it? Relieves LDS in thatch that won't wet, but will not leave thatch permanently wet. It will dry down like any part of the green, but allow water to continue to re-wet the area when Tournament-Ready is in use.

Note: Tournament-Ready does not require watering in and is non-phytotoxic but to achieve the results mentioned above, it is recommended to water in the product following application.



Tournament-Ready®



ordering

Part # UHTUR02	TOURNAMENT-READY (2.5 Gal / 9.48 Liter Jug) Soil Surfactant
Part # UHTUR30	TOURNAMENT-READY (30 Gal / 114 Liter Drum) Soil Surfactant
Part # UHTUR55	TOURNAMENT-READY (55 Gal / 208 Liter Drum) Soil Surfactant
Part # UHTUR265	TOURNAMENT-READY (265 Gal / 1003 Liter Tote) Soil Surfactant



H2O Maximizer™ LIQUID

NONIONIC SOIL SURFACTANT, POLYMER RESIN BLEND

- Unique soil surfactant and polymer resin blend that can be tank mixed for spray application or injected directly into irrigation flow
- Surfactant ingredients provide initial soil wetting action while polymer resin adsorbs to soil particles for enhanced water retention
- Reduced watering requirements are achieved through surfactant's reduction of surface tension combined with polymer resin's attachment to soil particles for greater water holding capacity to guard against plant stress
- Polymer resin boosts water retention in soil to deliver enhanced residual activity

2.5 Gal / 9.48 L / 2 per case
30 Gal / 113 L drum

ordering

Part # UHHMAX02 H2O MAXIMIZER (2.5 Gal / 9.48 Liters Jug) Surfactant/Polymer Resin Blend
Part # UHHMAX30 H2O MAXIMIZER (30 Gal / 114 Liters Drum) Surfactant/Polymer Resin Blend



Medalist® Spray +

ECONOMICAL NONIONIC SOIL SURFACTANT BLEND FOR SEASON-LONG APPLICATIONS

- Medalist, when used in a scheduled, water management program, will eliminate turf localized dry spot and enhance turf quality while reducing watering frequency
- Medalist's lower active formula incorporates the same university tested ingredients found in Tournament-Ready Soil Surfactant to deliver comparable performance to leading competitive products at a reduced price
- Get the most out of rain and irrigation
- Saves money on water and energy costs

2.5 Gal / 9.48 L / 2 per case
30 Gal / 113 L drum

ordering

Part # UHMED02 MEDALIST (2.5 Gal / 9.48 Liters Jug) Soil Surfactant
Part # UHMED30 MEDALIST (30 Gal / 114 Liters Drum) Soil Surfactant



Hydro-Wet® Injectable LIQUID

NONIONIC SOIL AND TURF WETTING AGENT FOR IRRIGATION INJECTION

- Hydro-Wet Injectable improves infiltration and penetration of rainfall and irrigation water
- Minimizes water loss due to run-off and evaporation
- Formulated for use with irrigation system metering equipment
- Hydro-Wet's high affinity for water drives down surface moisture to avoid spongy turf and standing water
- When university tested in comparison to 10 leading competitors, Hydro-Wet provided superior performance at reducing soil repellency

ordering

Part # UHHYI30 HYDRO-WET INJECTABLE (30 Gal / 114 Liters Drum) Liquid Concentrate

30 Gal / 114 L drum



Tournament-Ready® Plus™ with Actosol® Pellets



PROVEN TOURNAMENT-READY FORMULA W/ ACTOSOL AND MICRONUTRIENTS

- A combination of Tournament-Ready proven formula but with the addition of humic and fulvic acid, and micronutrients
- Uniform moisture management (doesn't bind in the thatch layer)
- Increases soil moisture without causing "spongy turf" problems
- The multiple benefits of humic and fulvic acids, calcium, and iron

ordering

Part # UHTRPLPEL TOURNAMENT-READY PLUS PELLETS (8 oz / 227 gm pellet - 16 pellets per case)

Tournament-Ready® Pellets

PROVEN TOURNAMENT-READY FORMULA IN SOLID PELLET FORM

8 oz Pellet Size!
better value
than competitors



- Same University tested formula in solid pellet for supplemental treatments
- Treat small turf areas while hand watering using Underhill PelletPro applicator
- Inert binder is carrier for Tournament-Ready Soil Surfactant for metered hand watering
- Tournament-Ready Pellets help cool canopy temperatures of turfgrass during high heat, stress conditions
- Pellet jar can be inserted in pellet applicator reservoir to modulate soil surfactant output

ordering

Part # UHTRPEL TOURNAMENT-READY PELLETS (8 oz / 227 gm pellet - 16 pellets per case)

H2O Maximizer® Pellets



HOLD MORE PLANT AVAILABLE WATER W/ H2O MAXIMIZER PELLETS

- Increase irrigation and rain efficiency by enhancing plant available water
- Improve water infiltration and water holding capacity of soil
- Remains active in the soil for 4-6 weeks, then bio-degrades into natural materials
- Polymer resin delivers increased plant available water

ordering

Part # UHH2OPEL H2O MAXIMIZER PELLETS (8 oz / 227 gm pellet - 16 pellets per case)

Wet-Pell™ Tournament-Ready® Blocks



PROVEN TOURNAMENT-READY FORMULA IN SOLID BLOCK FORM

- Same Proven Tournament-Ready Formula in a large application wet well block
- Apply wetting agent w/ ease to large areas by dropping into your wet well
- Inexpensive & almost no labor
- Includes two 8 pound pellets

ordering

Part # UHTRPEL-8 2 TOURNAMENT-READY WET-PELL BLOCKS (8 lbs each / 3.63 kg block)

Salt Buster Pellets

NEW!

PROVEN SALT BUSTING FORMULA IN PELLET FORM



- SaltBuster is a highly effective penetrant that drives water through the soil to help leaching
- Calcium added for Sodium remediation
- Works great for spot treating areas with our PelletPro inline applicator added to our SpotShot™ sprinklers. Let leach overnight and see the results!

ordering

Part # UHSBPPEL SALT BUSTER PELLETS (8 oz / 227 gm pellet - 16 pellets per case)



PelletPro™

APPLICATOR GUN FOR SOLID WETTING AGENT TABLETS

Our heavy-duty surfactant applicator, high-flow valve and Precision™ Cloudburst™ nozzle combo comprises the finest wetting agent gun available. PelletPro™ accepts all wetting agent tablets and provides a high volume, yet soft spray for watering or applying surfactants to tight, hydrophobic soils.



PelletPro™ rotates pellets at one revolution per second (RPS) to evenly dissolve/apply wetting agent

features

- 35+ GPM to get the job done faster!
- Ultra Heavy-Duty construction: brass fittings, aircraft aluminum, stainless steel, precision engineered glass
- Pellet rotation (1 RPS) evenly dissolves/applies tablets

SCAN to learn more!



ordering

- | | | |
|---------------------|---|---|
| Part # A-PPWA50K | PelletPro™ Applicator Gun (with 1" NPSH x 3/4" GHT adapter) |  |
| Part # A-PPWA50K-E | PelletPro™ Applicator Gun (with 3/4" quick-connect adapter) | |
| Part # A-PPQ-075 | PelletPro™ In-line Applicator: 3/4" GHT inlet, 3/4" GHT outlet | |
| Part # A-PPQ-100 | PelletPro™ In-line Applicator: 1" NPSH inlet, 1" GHT outlet | |
| Part # A-PPWASHNK | PelletPro™ Applicator Gun (with 1" NPSH x 3/4" GHT Adaptor) with RainPro Nozzle | |
| Part # A-PPWASHNK-E | PelletPro™ Applicator Gun (with 3/4" quick connect adaptor) with RainPro Nozzle | |
| Part # A-PPB | In-line Filter Bowl (gasket not included) | |
| Part # A-PPBG | Gasket | |

WETTING AGENT PELLETT SELECT GUIDE

PRODUCT	FUNCTION	APPLICATIONS OUTSTANDING FOR:
Tournament Ready® Plus™ with Actosol® Pellets SPECIALTY	<ul style="list-style-type: none"> ▪ Penetrates ▪ Hydrates LONGER under ALL conditions ▪ Root Enhancing 	<ul style="list-style-type: none"> ▪ Greens 
Tournament Ready® Pellets	<ul style="list-style-type: none"> ▪ Penetrates ▪ Hydrates LONGER under ALL conditions 	<ul style="list-style-type: none"> ▪ Greens
H2O Maximizer® Pellets SPECIALTY	<ul style="list-style-type: none"> ▪ Penetrates ▪ Ultra Hydration 	<ul style="list-style-type: none"> ▪ Bunker Facings ▪ New Sod/Seeding ▪ Fairways ▪ Roughs Economy Choices: <ul style="list-style-type: none"> ▪ Approaches ▪ Tees ▪ Roughs ▪ Fairways
Wet-Pell™ Blocks Tournament Ready®	<ul style="list-style-type: none"> ▪ Apply Wetting Agent w/ Ease To Large Areas by Dropping into Your Wet Well ▪ Inexpensive & Almost No Labor 	<ul style="list-style-type: none"> ▪ Fairways ▪ Tees ▪ Roughs
Salt Buster Pellets SPECIALTY	<ul style="list-style-type: none"> ▪ Highly effective penetrant that drives water through the soil to help leaching ▪ Calcium added for Sodium remediation 	<ul style="list-style-type: none"> ▪ Fairways ▪ Tees ▪ Roughs

SPECIALTY PRODUCTS

Benchmark™

ALL SEASON FOAM MARKER

- This foam concentrate is specially formulated to deliver long lasting foam in a range of weather and field conditions
- This highly concentrated formula, when used as directed will produce thick, white, highly visible foam. Benchmark can be used with any compressed air foam marking equipment to provide long lasting foam deposits on turf or soil areas to avoid over-sprays or skips
- Benchmark is formulated with conditioners for hard water situations and can be used with foam colorants

ordering

Part # BMK01 BENCHMARK Foam Marking Agent (1 Gal / 3.79 Liters Jug)



1 Gal / 3.79 L jug
4 per case



1 lb / 456 gm jar
12 per case

Tank Cleaner™

DRY TANK & EQUIPMENT CLEANER

- Tank Cleaner is designed for cleaning tanks, lines and nozzles to remove pesticide, herbicide and fertilizer residues
- Tank Cleaner also removes light rust and dissolves deposit buildups while leaving a protective film that helps prevent corrosion
- Color dye in Tank Cleaner indicates ingredients are still active in solution

ordering

Part # TC01 TANK CLEANER (1 lb / 456 gm Jar)



Anti-Foam™

ANTIFOAMING AND DEFOAMING AGENT

- Anti-Foam is a fast, effective defoamer for use in suppressing foam, controlling foam reduces filling time and lessens overflow waste
- Anti-Foam improves spray performance
- Silicone and surfactant blend work in tandem to quickly dissipate troublesome foam that forms during agitation

ordering

Part # AF1Q ANTI-FOAM (1 Qt / 946 ml Bottle)



1 Gal / 3.79 L jug
4 per case

K-Klean™

LIQUID TANK CLEANER

- K-Klean is an effective cleaner for metal, fiberglass and plastic spray systems
- K-Klean aids in the removal of dirt, grime, grease, chemical and fertilizer residues from tanks and equipment
- K-Klean helps eliminate rust and scale and keeps costly equipment in ready-to-use condition

ordering

Part # KKLEAN01 K-KLEAN (1 Gal / 3.79 Liters Jug)



1 Qt / 946ml jug
12 per case

Bio-90™

NONIONIC SURFACTANT/TANK MIX ADJUVANT

- Use Bio-90 when accompanying pesticide label instructions recommend the use of a nonionic surfactant tank mix adjuvant
- Bio-90 optimizes the performance of turf fungicides, insecticides and herbicides
- Use Bio-90 when uniform spray coverage and penetration into the targeted plant surface is preferred
- Bio-90 contains rainfast ingredient to minimize wash-off
- Bio-90 contains an antifoam ingredient to suppress troublesome foam during agitation

ordering

Part # BI901Qt Bio-90 (1 Qt / 946ml Jug)



4 lb / 1.8kg jar
6 per case

Water FX™

DRY WATER CONDITIONER / ACIDIFYING AGENT ADJUVANT

- Water FX effectively sequesters hard water minerals such as calcium, magnesium and iron that can interfere with many pesticide active ingredients
- Water FX lowers spray water pH to ensure full effectiveness of many insecticides, fungicides and herbicide sprays that perform better in moderately acidic water
- Certain pesticide active ingredients will be more effective and are more readily available to the plant with the use of Water FX

ordering

Part # WFX04 WATER FX (4 lb / 1.8 kg Jar)



Liquid Applicators



LiquidPro™

APPLICATOR GUN FOR LIQUID WETTING AGENT

LiquidPro's chemical-resistant, UV-protected, lightweight siphon mixing system can cover 1000 square feet in less than a minute! With unmatched speed and uniformity, you can virtually "paint" your turf with liquid wetting agent, fertilizers, and micronutrients. Adjustable metering dial offers 10 additive settings including "Water Only."
LiquidPro requires minimum 50 Psi operating pressure to the inlet side of the unit to function properly.



ordering

Part # A-LPWA50K	LiquidPro™ Applicator Gun (with 1" NPSH x 3/4" GHT adapter) 
Part # A-LPWA50K-E	LiquidPro™ Applicator Gun (with 3/4" quick-connect adapter) 
Part # A-LPWWASHNK	LiquidPro™ Applicator Gun (with 1" NPSH x 3/4" GHT Adaptor) with RainPro Nozzle
Part # A-LPWWASHNK-E	LiquidPro™ Applicator Gun (with 3/4" quick connect adaptor) with RainPro Nozzle
Part # A-LPWAB-6	6-Pack of 32 oz. Polybottles and Carrier

RainPro™ Nozzle



Now available on
PelletPro and LiquidPro
 Applicator Guns!



Flo-Pro™ Inline

IN-LINE APPLICATOR FOR LIQUID WETTING AGENT

The lightweight portable solution to apply surfactant to tight hydrophobic soils. Also, ideal for liquid or soluble fertilizers and soil amendments. Easy connection to water source (quick coupler, HoseTap, etc). Just attach your favorite nozzle like the Precision Cloudburst or RainPro and your ready to go.



features

- Larger 1 gallon tank
- Made of high impact PVC
- Adjustable feed rate
- Can also apply fertilizers and soil amendments

ordering

Part # IHB-1010 Inline applicator includes coupling and On/Off ball valves

GRUND GUIDE by Underhill® Marking Systems



SPEED AND QUALITY OF PLAY...GOLF AS IT SHOULD BE.

You know Grund Guide for making premier yardage marking solutions. Now backed with the strength of Underhill® distribution and product development, you can have the highest quality and most complete yardage marking systems available today and into the future.

Sprinkler Head Yardage Markers

ENGRAVED CAPS



MODEL SPM 106 - TORO ENGRAVED CAPS:
Perfect-fit caps engraved and color filled for high visibility. Multiple number locations vary for lids with holes



FITS:

Toro 730, 750, 760, 780, 830/850S, 834S, 835S, DT34/35S, 854S, DT54/55, 860S, 880S, INF & FLEX series

COLORS:

Caps ●/○/●/●
Numbers ○/●/●/●/●/●/●



MODEL SPM 107 - RAIN BIRD ENGRAVED CAPS:
Perfect fit caps engraved and color filled for high visibility number identification



FITS:

Rain Bird E900, E950, E700, E750, E500, E550, 700, 751, 51DR

COLORS:

Caps ●/○/●/●
Numbers ○/●/●/●/●/●/●



MODEL SPM 110 - HUNTER ENGRAVED CAPS/COVERS:
Perfect-fit flange covers (G800, G900) and caps (G90), engraved and color filled for high visibility.



FITS:

Hunter G800, G900, G90

COLORS:

Flange cover/caps ●
Numbers ○/●/●/●/●/●/●

ALSO AVAILABLE: BLANK REPLACEMENT CAPS FOR TORO, RAIN BIRD, HUNTER!

Tired of paying too much for OEM caps? Now ALL caps are available without yardage markings, just use Model # and OEM Series for ordering!

METAL ENGRAVED DISCS



MODEL SPM 101 - FIT OVER DISCS:
Anodized aluminum (no paint!), these markers are engraved and custom fit to each sprinkler. Multiple number locations vary for lids with holes.



FITS:

Toro 630, 650, 660, 670, 680, 690, 830/850S, 834S, 835S, DT 34/35, 854S, 855S, DT 54/55, 860S, 880S, INF & FLEX series
Rain Bird 47/51 DR, 71/91/95, E900, E950, E700, E750, E500, E550, 1100, Hunter G-70/75, G-90/95, G-990, G-995, John Deere/Signature – Call

COLORS:

Discs ●/●/●
Numbers ●

SNAP-IN MARKERS



MODEL SPM 103 INFINITY - TORO SNAP-IN MARKERS:

OEM UPGRADE to high quality polycarbonate custom fit. One complete, high-visibility marker snaps into OEM plug.



FITS: ALL INFINITY SERIES

COLORS:

Caps ●/○/●/●

Numbers ○/●/●/●/●/●/●

INFINITY SERIES

FITS: Toro 730, 750, 760, 780, 830/850S, 834S, DT 34/35, 854S, DT 54/55, 860S, 880S

COLORS: Snap in ○/●/●

Numbers ○/●

(Reclaimed water - ● no number - available)



MODEL SPM 103 - TORO SNAP-IN MARKERS:

OEM UPGRADE to high quality polycarbonate custom fit. One complete, high-visibility marker snaps into OEM plug.



UNIVERSAL METAL ENGRAVED DISCS



MODEL SPM 105 - FITS MOST HEADS & COLLARS:

Anodized aluminum (no paint!), these markers are engraved and designed for most universal fit applications. Tags are installed using 1/8" rivets.



FITS:

Option Universal Crescent 2-7/8"W x 1"H

Round Edge 3"W x 1"H

Square Edge 2"W x 3/4"H

COLORS: Tags ●/●/●

Numbers ●

BOND-IN MARKERS



Model SPM 108 - TORO & Hunter:

Special engraved plastic material designed to fit into OEM lid recess

FITS: Toro 730, 750, 760, 780, 834S, DT 34/35, 854S, DT 54/55, 860S, 880S and Hunter G800, G70/75B, G870, G875, G880, G885, G990, G995

COLORS: Markers - ○/●, Numbers - ●



Model SPM 104 - Lid/Molded Recess Markers:

Durable replacement lid, with reverse engraved number insert process. Excellent number ID with this model

FITS: Rain Bird 47, 51

COLORS: Lid - ●/○/●

Insert - ○/●/●

Numbers - ○/●

SCAN
to learn more!



ordering example

Marker Model	Sprinkler Mfg	Series	Marker Color	# Color	Qty. of #s on Marker	Total QM on Order
SPM-106	Toro	730	Black	Yellow	1	76

Scan this QR code for Order Form

SPECIAL SERVICES

WE OFFER TURN-KEY SOLUTIONS!

Call for detail and quotes!

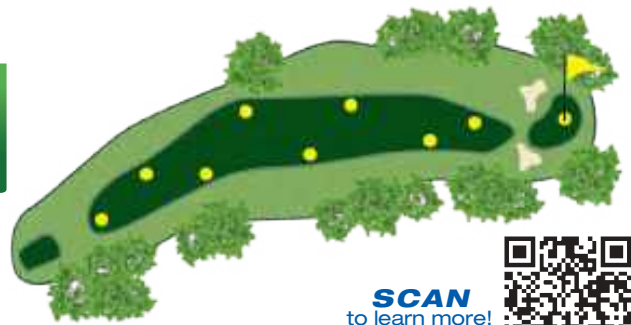

SCAN
to learn more!



MAINTENANCE

- Full Course "Walk-Thru", check all current sprinklers, create list of marker repairs.

ordering

SPM-MAINT-09	9 Hole Course
SPM-MAINT-18	18 Hole Course

MEASUREMENT

- LASER Pin point measurement to center of greens

ordering

SPM-MEAS-09	9 Hole Course
SPM-MEAS-18	18 Hole Course

INSTALLATION

- Yardage Marker Installation by Underhill Field Rep, Golf course staff.

ordering

SPM-INSTALL-09	9 Hole Course
SPM-INSTALL-18	18 Hole Course

GRUND GUIDE

Fairway / Tee / Range Disc Markers

Large 7 1/2" cap with big bold 3 1/2" standard yardage numbers. Ideal for fairway, tee and driving range marking. Optional 8" mounting pipe attachment available for secure installation.

FAIRWAY STANDARD DISC SYSTEM

Color-coded markers with bold 3 1/2" yardage number. Several system options available.



FAIRWAY CUSTOM OPTIONS

Markers can be customized to display specific yardage numbers, include logos, or custom design.



TEE BOX / DRIVING RANGE CUSTOM OPTIONS

Markers can be customized to display specific multiple numbers, include logos, or custom design.



Disc Marker pictured with optional 8" mounting pipe (installs easily with standard cup cutter)

SYSTEM EXAMPLES

- A: 3 markers placed down the center of the fairway at 50 yard intervals
- B: 5 markers placed down the center of the fairway for greater coverage
- C: Markers placed on sides and center ("diamond" layout) for highest visibility
- D: Create a custom system with your choice of color and numbers/markings

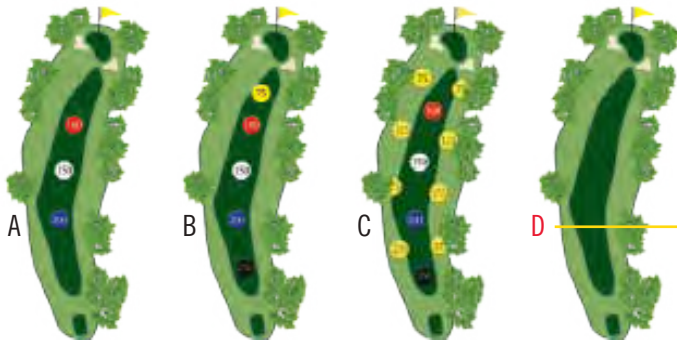

Valve Box / Universal Markers

These engraved, anodized aluminum (no paint!) markers are ideal for isolation or control valves, satellites or other applications.



ordering

Standard Disks with Markings

- FTM-Y-75 ● Yellow Disk with 75
- FTM-R-100 ● Red Disk with 100
- FTM-W-150 ○ White Disk with 150
- FTM-BL-200 ● Blue Disk with 200
- FTM-BK-250 ● Black Disk with 250
- FTM-RWB-KIT 3 Disks with Yardages (●/○/●)
- FTM-YRWB-KIT 5 Disks with Yardages (●/●/○/●/●)

Custom Disks for Fairway, Tee Box and Driving Range

- FTM-Y ● Yellow Disk no markings
- FTM-O ● Orange Disk no markings
- FTM-R ● Red Disk no markings
- FTM-W ○ White Disk no markings
- FTM-BL ● Blue Disk no markings
- FTM-BK ● Black Disk no markings
- FTM-G ● Green Disk no markings
- FTM-L ● Lavender Disk no markings

Tee Box / Fairway / Driving Range Custom Markings

- To order, add to end of custom disk part numbers above.
 Example: FTM-Y-#1 (Yellow Disk with One custom number)
- XXXX-#1 One custom number to disk
 - XXXX-#2 Two custom numbers to disk
 - XXXX-#3 Three custom numbers to disk
 - XXXX-CUST Custom Design; Script
 - XXXX-LOGO Logo added to disk
 - XXXX-#4 up to 4 flags / targets / yardages
 - XXXX-#8 5 to 8 flags / targets / yardages
 - XXXX-#12 9 to 12 flags / targets / yardages

Accessories

- FTM-PL 8" Mounting Pipe for all disks

Valve Box / Universal Markers

- SPM-105-B Black anodized marker
- SPM-105-M Maroon anodized marker

INNOVATIVE MERCHANDISING SOLUTIONS

**PRO SERIES
COMBO TOWER**



**PREMIUM SERIES
ACCESSORY TOWER**



**ULTRA SERIES
HOSE TOWER**



All Tower Dimensions: 84" h x 24" w x 24" d

**GULP
PUMP
DISPLAY**



Display Dimensions:
43" h x 29 1/4" w x 17" d

COUNTER DISPLAY



**Our Attention Grabbing
Merchandising Displays
are Clean, Efficient
& Effective**

Order Literature:

- | | |
|----------------|---------------------------|
| LIT-UI2024 | 2024 Catalog |
| LIT-NEW-D23 | 2024 New Product Showcase |
| LIT-GULP-A24 | PowerGulp & GulpPro Flyer |
| LIT-FW-A24 | Featherweight Flyer |
| LIT-HC-A24 | Hose Caddy Flyer |
| LIT-POP-A24 | Hose Tower Program Flyer |
| LIT-H&NMAT-A24 | Hose & Nozzle Matrix |

WHAT MAKES UNDERHILL SPECIAL?

HIGH QUALITY, HAND CRAFTED, PROBLEM-SOLVING IRRIGATION PRODUCTS THAT MAKE YOUR JOB EASIER



WE SUPPORT OUR INDUSTRY



SUPERIOR CUSTOMER SERVICE
ORDER TODAY, SHIPS TOMORROW
2 YEAR, NO-HASSLE WARRANTY

Underhill®



Distributed by:

CENTAUR
ASIA PACIFIC

Hong Kong | Singapore | Malaysia | Australia

Email: info@centaur-asiapacific.com

Website: www.centaur-asiapacific.com

SCAN
to learn more!



©2024 Underhill International Corporation. All original equipment manufacturers, names and products presented in this publication are used for identification purposes only, and we are in no way implying that any of our products are original equipment parts. Toro® is a registered trademark of the Toro Company, Rain Bird® is a registered trademark of the Rain Bird Sprinkler Manufacturing Corporation, Hunter® is a registered trademark of Hunter Industries. Buckner® is a registered trademark of Storm Manufacturing Group, Inc. Signature® is a registered trademark of Signature Control Systems, Inc. Milwaukee® is a registered trademark of Milwaukee Tool. Makita® is a registered trademark of Makita USA. DeWALT® is a registered trademark of the Dewalt corporation. Bosch® is a registered trademark of the Robert Bosch LLC.