

# BROCHURE

| ROBOTS | TECHNOLOGIES | TECHNICAL DATA |





**A perfect cut without human intervention.  
That is our promise to you.**



**Our robotic lawnmowers are designed to meet your requirements. Welcome to the world of ECHO Robotics.**

**Automatic mowing saves time and labour.  
But we still need to find robots that deliver on their promises.**

So how about getting to know the brand that pioneered the sector?

**SINCE 2002**, our teams have been imagining, designing and manufacturing our range of robots in Belgium. Our innovations and the features of our robots are a direct result of the experience and interaction we have with our users in the field.

**FOR PROFESSIONALS**

Sports clubs, companies, private or public parks? We know your requirements in terms of lawn quality. You can count on durable, robust, high-performance and reliable equipment. Our machines are designed using only the highest quality materials.

Discover our range of exceptional robots.



**Diederick Geerinckx**  
Sales & Marketing Manager  
Yamabiko Europe

<p><b>Innovation:</b> Wisnav® GPS-RTK navigation without boundary wires</p>	<p><b>Performance:</b> exceptional robustness and results</p>	<p><b>Durabilité:</b> natural mowing and low energy consumption</p>	<p><b>Économies:</b> 50% savings on energy, maintenance and labour</p>
---	---	---	--



# Exclusive benefits

## What makes us different



### 50% MORE ECONOMICAL

- Optimised labour.
- Limited maintenance
- Robust materials
- Low power consumption

### Ecological



#### solution

- CO<sub>2</sub> emissions cut by 90%
- Natural mowing without chemical fertilisers
- Perfect mulching, no waste
- Installation without boundary wires (Wisnav®)

### AUTONOMY 24/7

- Day and night operation
- Quality cutting in all weathers
- An attractive lawn all the time
- Saves time and labour



#### Advanced

### Technology

- GPS-RTK navigation and Wisnav® technology
- Web portal and mobile application
- Mowing capacity: up to 75,000 m<sup>2</sup>
- Up to 15,000 golf balls in 24 hours

### Sustainable



#### solution

- Sturdy materials
- Designed for long-term use
- Powered by rechargeable battery
- Durable aluminium chassis

### Robust

#### grass



- Frequent mowing promotes growth
- Mulching and natural fertilisation
- Floating heads that adapt to the terrain
- Protection against overgrowth

### Large areas and fleet

- Cutting width up to 103 cm
- Designed for large areas
- Remote fleet management
- Remote software updates and configuration





# On-board technology

Smartbox with ultra-powerful processors enabling evolution over several years

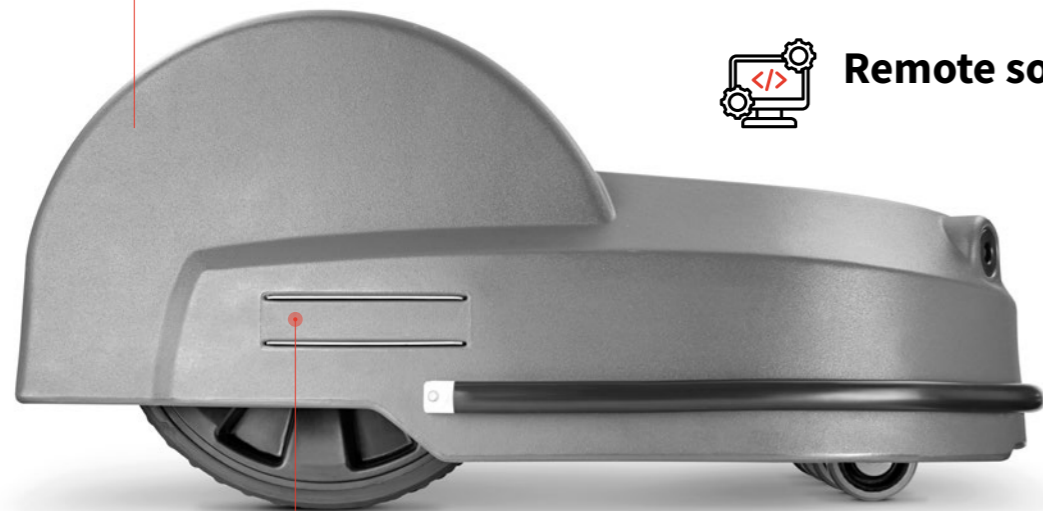

Remote software update



Silent



Non-corrosive charging contacts



Easy maintenance



Aluminium chassis



All-weather tyre tread

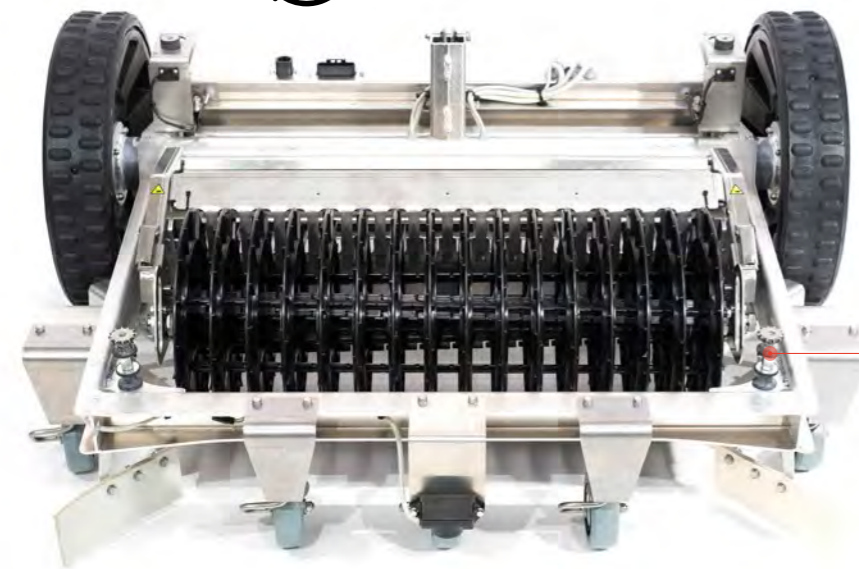

Front silent blocks

# Safety and performance

STOP button



Waterproof extremely sturdy cover



Electronic contact strip



5 SONAR UNITS

Propulsion motor housing

Electronic cutting height adjustment

Rear silent blocks

Battery

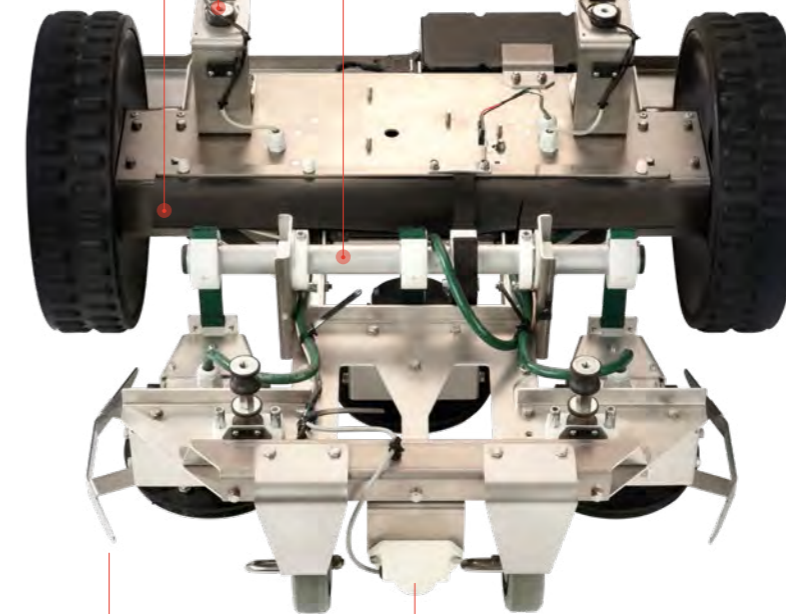

Safety deflectors

Magnetic field detector

## Robust equipment

- With or without guide wire
- Pattern mowing
- Work zones
- No-go areas
- Web portal and app
- Fleet management
- Mowing pattern optimisation
- Low-voltage charging station
- Multi-zone operation and large surfaces
- Sonar and sensors
- Cutting blades equipped with protective deflectors.
- Blade rotation stops when mower is lifted
- Anti-theft system
- Clean cut
- 100% natural mulching
- Slopes of up to 45%
- Maximum 52 dB A
- All-weather performance

TECHNOLOGY **WISENAV**<sup>®</sup>



# App & Portal

An unrivalled user experience



## The ECHO Robotics portal and app work in parallel.

To be even more useful to you. Thanks to these, your personal login gives you access to new features that are unique on the market: modify settings and process notifications remotely, geolocate and filter according to your criteria, and have access to technical support from your dealer in real time and remotely.

## A tailor-made subscription package

- We offer four types of package and prices according to your needs and the type of robot you have.
- Decide which package suits you best by looking at the table or contact your dealer/supplier for more information.

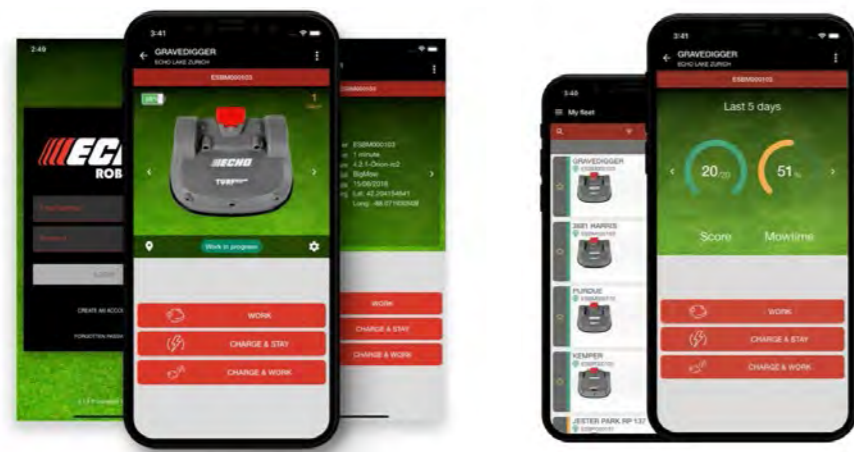
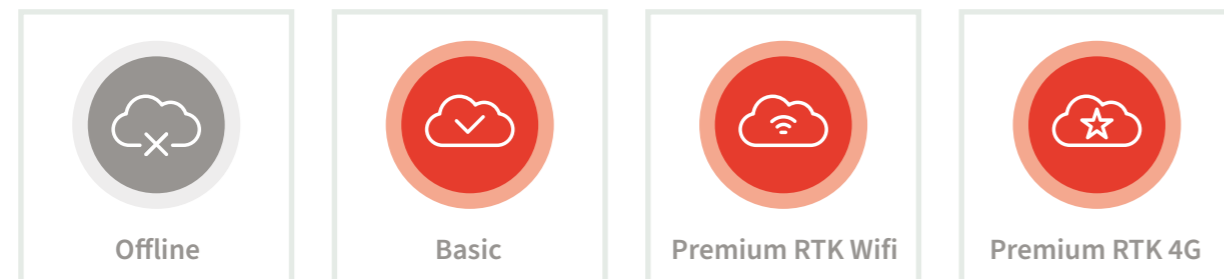

Features	Offline	Basic	Premium RTK Wifi	Premium RTK 4G
	We guarantee software updates during technical maintenance operations.	The most complete package on the market for users wishing to take full advantage of remote control of their connected robot.	The subscription for users of GPS-RTK robots who want control of their operations to be at their fingertips.	The most comprehensive subscription for users of GPS-RTK 4G robots, including data subscription and robot management via a single 4G terminal with a 15-km radius.
Software updates	✓	✓	✓	✓
Performance monitoring (history&cycles)	✓	✓	✓	✓
Remote user controls	-	✓	✓	✓
Remote configuration of the robot (read/write parameters)	-	✓	✓	✓
Alarm and notification management (updates, subscription renewals, etc.)	-	✓	✓	✓
Status in real time + position on demand	-	✓	✓	✓
Interactive map: tracking the trajectory by cycles	-	✓	✓	✓
Fleet management dashboard	-	✓	✓	✓
Maintenance logbook	-	✓	✓	✓
Mowing configuration and settings by GPS Pattern	-	-	✓	✓
Remote configuration of zones by GPS	-	-	✓	✓
No-go zones for obstacles based on GPS	-	-	✓	✓
Wisnav®	-	-	✓	✓
4G GPS-RTK Base station within a 15-km radius	-	-	-	✓



# Robot mowers and golf ball collectors

12,000 M<sup>2</sup>



## TM-1000 Connected Line



- Mowing capacity: up to 12,000 m<sup>2</sup>
- Estimated electricity cost: €200/year
- Cutting method: 3 floating heads
- Safety: 5 sonar units
- Cutting width: 63.3 cm

30,000 M<sup>2</sup>



## TM-850S GPS-RTK



- Mowing capacity: up to 30,000 m<sup>2</sup>
- Estimated electricity cost: €150/year
- Cutting method: 2 floating heads
- Safety: 2 sonar units
- Cutting width: 42 cm
- Perfect, constant mulching

## TM-1050 GPS-RTK



- Mowing capacity: up to 45,000 m<sup>2</sup> (Wisnav®)
- Estimated electricity cost: €200/year
- Cutting method: 3 floating heads
- Safety: 5 sonar units
- Cutting width: 63.3 cm
- Uniform strip mowing

45,000 M<sup>2</sup>



## TM-2000 Connected Line



- Mowing capacity: up to 24,000 m<sup>2</sup>
- Estimated electricity cost: €290/year
- Cutting method: 5 floating heads
- Safety: 5 sonar units
- Cutting width: 103 cm
- 45% slope kit option

24,000 M<sup>2</sup>



75,000 M<sup>2</sup>



## TM-2050 GPS-RTK



- Mowing capacity: up to 75,000 m<sup>2</sup> (Wisnav®)
- Estimated electricity cost: €300/year
- Cutting method: 5 floating heads
- Safety: 5 sonar units
- Cutting width: 103 cm
- Three times greater mowing capacity

## RP-1200 Connected Line



- Operating area: 30,000 m<sup>2</sup>
- Estimated electricity cost: €220/year
- Collection method: 16 discs
- Safety: 4 sonar units
- Pick-up capacity: up to 12,000 balls / 24 hours
- Multi-zone function

30,000 M<sup>2</sup>



## RP-1250 GPS-RTK



- Operating area: 45,000 m<sup>2</sup>
- Estimated electricity cost: €240/year
- Collection method: 16 discs
- Safety: 4 sonar units
- Pick-up capacity: 15,000 balls / 24 hours
- "No-go zone" feature

45,000 M<sup>2</sup>



Want to know which robot is right for your project?  
**Discover our three-step selection tool**





# Connected Line

For independent mowing

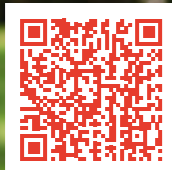

## TM-1000 CONNECTED LINE



12,000  
M<sup>2</sup>

### Technology

GPS guidance system  
Automatic charging  
Web portal + App

### Cutting

Cutting width: 63.3 cm  
3 floating heads  
Instant adaptation to terrain  
9 stainless steel blades  
5 safety sonar units  
Perfect, constant mulching

### ADVANTAGES

Capacity up to 12,000 m<sup>2</sup>  
100% ecological  
Max. 52 dB (A)  
10 times lower CO<sub>2</sub> emissions  
Eight times lower energy costs



### Technical data

(L)100 x (W)104 x (H)46 cm

Max. 12,000 m<sup>2</sup> (24/7)

3 floating heads 3000 rpm

5 sonar units diameter 5 cm

52 dB (quietest robot on the market)

LiFePO<sub>4</sub> battery – 19.2 Ah

Cutting height 20-100 mm

Average annual electricity consumption 580 kWh

Fleet management system

Slope 35%



# TM-2000 CONNECTED LINE



24,000 M<sup>2</sup>

## Technology

GPS guidance system  
Automatic charging  
Web portal + App

## Cutting

Cutting width: 103 cm  
5 floating heads  
Instant adaptation to terrain  
15 stainless steel blades  
5 safety sonar units  
Perfect, constant mulching

# RP-1200 CONNECTED LINE



12,000 BALLS / 24 HOURS

## Technology

GPS guidance system  
Automatic charging  
Web portal + App

## Ball picking

Capacity up to 30,000 m<sup>2</sup>  
16 anti-friction pick-up discs  
Ball safety deflectors  
4 safety sonar units

## ADVANTAGES

Capacity up to 24,000 m<sup>2</sup>  
100% ecological  
Max. 52 dB (A)  
Slope from 30% to 45% (with kit)  
Able to mow several adjacent fields

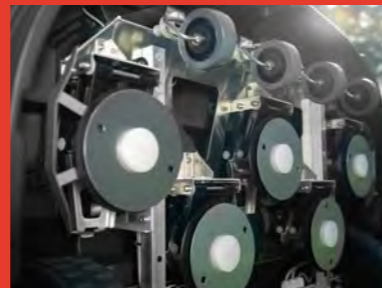

## ADVANTAGES

Patented worldwide exclusivity  
Able to pick up on several adjacent fields  
Pick-up and drop-off day and night  
Perfect combination with TM-2000 golf

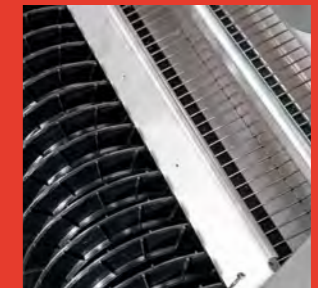

## Technical data

(L)111 x (W)127 x (H)51 cm

Max. 24,000 m<sup>2</sup> (24/7)

5 floating heads 3000 rpm

5 sonar units diameter 5 cm

52 dB (quietest robot on the market)

LiFePO4 battery – 19.2 Ah

Cutting height 20-100 mm

Average annual electricity consumption 830 kWh

Fleet management system

Slope of 30% as standard and 45% with the kit

## Technical data

(L)118 x (W)134 x (H)54 cm

5 groups of 4 polyethylene discs

Ball tank for 320-350 balls

Multizone programming

4 sonar units diameter 5 cm

52 dB

LiFePO4 battery – 19.2 Ah

Fleet management system

Slope 30%

Average annual electricity consumption 620 kWh



# GPS-RTK

For strip mowing



# TM-850S GPS-RTK

For sports fields



## Technology

GPS-RTK navigation  
Automatic front-loading  
Web portal + App

## Cutting

Cutting width: 42 cm  
2 floating heads  
6 blades, 2 safety sonar units  
Perfect, constant mulching



## ADVANTAGES

Strip pattern mowing  
Without boundary wire (Wisenav®)  
Ultra-light (25 kg)  
Simplified keyboard



## Technical data

(L)87 x (W)70 x (H)32 cm

2 floating heads 3000 rpm

2 sonar units diameter 5 cm

52 dB (quietest robot on the market)

LiFePO4 battery – 8.55 Ah

Cutting height 20-70 mm

Cutting width 420 mm

Average annual electricity consumption 400 kWh



# TM-1050 GPS-RTK



45,000 M<sup>2</sup>

## Technology

GPS-RTK navigation  
Automatic charging  
Web portal + App

## Cutting

Cutting width: 63.3 cm  
3 floating heads  
Instant adaptation to terrain  
9 stainless steel blades  
5 safety sonar units  
Perfect, constant mulching

WISENAV®

# TM-2050 GPS-RTK



75,000 M<sup>2</sup>

## Technology

GPS-RTK navigation  
Automatic charging  
Web portal + App

## Cutting

Cutting width: 103 cm  
5 floating heads  
Instant adaptation to terrain  
15 stainless steel blades  
5 safety sonar units  
Perfect, constant mulching

WISENAV®

## ADVANTAGES

Strip pattern mowing  
No overlapping of mowing  
Three times more capacity  
With or without boundary wire (Wisnav®)  
2-cm position accuracy.



## Technical data

(L)100 x (W)104 x (H)46 cm

3 floating heads 3000 rpm

5 sonar units diameter 5 cm

52 dB (quietest robot on the market)

LiFePO4 battery – 19.2 Ah

Cutting height 20-100 mm

Cutting width 63.3 cm

Average annual electricity consumption 580 kWh

Fleet management system

Slope 35%

## ADVANTAGES

Strip pattern mowing  
No overlapping of mowing  
Three times more capacity  
With or without boundary wire (Wisnav®)  
2-cm position accuracy.



## Technical data

(L)111 x (W)127 x (H)51 cm

5 floating heads 3000 rpm

5 sonar units diameter 5 cm

52 dB (quietest robot on the market)

Cutting height 20-100 mm

Cutting width 103.3 cm

Average annual electricity consumption 830 kWh

RTK options fairway & driving range discs

Fleet management system

Slope of 30% as standard and 45% with the kit

# RP-1250 GPS-RTK



## Technology

GPS-RTK navigation  
Automatic charging  
Web portal + App

## Collection

Capacity up to 45,000 m<sup>2</sup>  
16 anti-friction pick-up discs  
Strip navigation  
4 safety sonar units

**WISENAV**<sup>®</sup>

## ADVANTAGES

Strip pattern collection  
With or without boundary wire (Wisenav<sup>®</sup>)  
2-cm position accuracy.



## Technical data

(L)118 x (W)134 x (H)54 cm

4 sonar units diameter 5 cm

52 dB (quietest robot on the market)

LiFePO4 battery – 19.2 Ah

15,000 balls / 24 hours

Average annual electricity consumption 620 kWh

RTK Wifi + 4G options

Fleet management system

Pick-up width 95.6 cm

Slope 30%





# GPS-RTK technology

## Strip pattern mowing

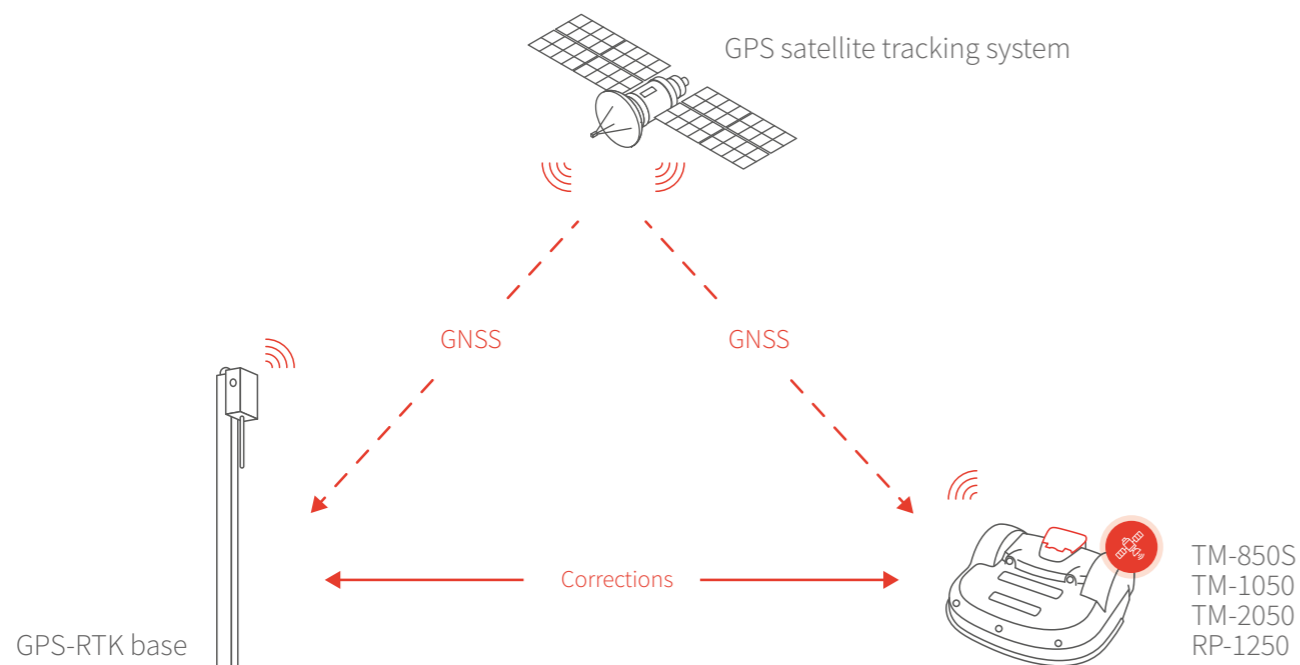

### RTK stands for Real Time Kinematic

Thanks to the link with a fixed GPS-RTK receiver (placed near the property), satellites from four constellations guide the robot's trajectory. Our technology makes it possible to mow a larger surface area in a strip pattern. Also available for golf ball pickers.

### Strip pattern mowing

Forget random mowing. GPS-RTK robots navigate in attractive strips with an accuracy of 2 cm.

### Three times more capacity

Achieve more in less time. GPS-RTK robots have a capacity of up to 75,000 m<sup>2</sup>.

### More economical and sustainable

Save money. Linear operation means less wear and tear and lower power consumption for GPS-RTK robots.

#### Advantages of GPS-RTK robots

- Ultra-precise navigation via GPS guidance
- Strip pattern mowing
- Three times greater mowing capacity
- Up to 75,000 m<sup>2</sup> (TurfMower GPS-RTK TM-2050)
- Installation without boundary wires (Wisnav<sup>®</sup> updates)
- 10 times lower CO<sub>2</sub> emissions
- 8 times lower energy costs
- No noise pollution
- 100% ecological
- Malfunction alert

# Wisnav<sup>®</sup> technology

## No boundary wires

### Wisnav<sup>®</sup> (Wireless Satellite Exact Navigation)

With the Wisnav<sup>®</sup> upgrade, GPS-RTK robots move up to the next level of precision and navigate without a boundary wire. Three times more mowing capacity and virtual demarcation of work and safety zones. Also available for golf ball pickers.

### Easy installation and demo

It is no longer necessary to install a boundary wire in the ground to configure the robot or carry out a demonstration. Thanks to the mobile application, the installer can now control the robot remotely to define work zones and no-go areas.

### Easy customisation of work on the portal

Use your mouse to customise the working perimeter, no-go zones, mowing angle, cutting height, etc. with just one click. A super-simple, intuitive experience!

### Easy management of transport paths

If the installation is complex and the robot has to move between several plots, don't worry. Thanks to Wisnav<sup>®</sup>, transport path configuration is user-friendly and offers infinite possibilities.

### Five steps to mowing without a boundary wire

1. 1 robotic mower equipped with GPS-RTK technology
2. 1 docking station
3. 1 Wifi or 4G GPS-RTK terminal
4. 1 Wisnav<sup>®</sup> GPS-RTK licence
5. (Virtual) demarcation of work and safety zones

## WISNAV<sup>®</sup>



Want to monitor your mowing?  
**Access the portal and mobile application**



# Sport Football

Partner to professional and amateur clubs

A football pitch in peak condition without human intervention.



## Case study

# Henri Guérin Training Centre of Brittany



The **Henri Guérin Training Centre of Brittany** hosts amateur and professional sports teams from a variety of disciplines. To optimise the maintenance of its football pitches, the centre now uses an ECHO Robotics robotic mower.

## Context

**Breizh Park.** The Training Centre has three football pitches. One of them, called La Plaine de Jeux ('The Playground'), has natural grass. This pitch required regular mowing and constant maintenance, which was very challenging for the maintenance personnel.

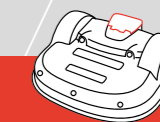

## ECHO Robotics solution

To satisfy these demanding maintenance requirements, the centre installed ECHO Robotics robotic mowers. These mowers provide precise cutting height adjustment (to within 25 mm) and a fast mowing cycle only four hours long.

## Results

- ✓ **Greater efficiency:** Mowing cycles are now completed in four hours, allowing more frequent and more regular maintenance.
- ✓ **Less use of fertilisers:** Uniform cutting allows a 20% reduction in fertiliser use, which strengthens grass health.
- ✓ **Improved ground quality:** By avoiding the use of heavy machinery, you reduce soil compaction, allowing better aeration and higher grass density.
- ✓ **Improved quality of play:** The players have noticed that the quality of play is better on grass that is always impeccable.

The introduction of ECHO Robotics robotic mowers has revolutionised the centre's approach to pitch care by improving the efficiency and sustainability of maintenance whilst also providing a better playing experience for the athletes.

# Sport Golf

Partner of golf clubs  
Course mowing and ball collection without human intervention



## Case study Naxhelet Golf Club



The Naxhelet Golf Club has adopted innovative maintenance solutions for its driving range and certain fairways, using ECHO Robotics technologies.

### Context

The Naxhelet Golf Club had a driving range and several fairways that required regular mowing and frequent ball collection. Manual maintenance was costly and time-consuming.

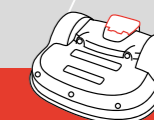

### ECHO Robotics Solution

The golf automated its maintenance with ECHO Robotics robotic mowers, automatic ball pickers, and a ball collector called Drop-pit.

### Results

- ✓ **Greater efficiency:** Autonomous maintenance of the grounds and automated ball collection.
- ✓ **Cost reduction:** Less need for labour and heavy machinery.
- ✓ **Enhanced quality:** Perfectly mown grass and no balls scattered on the course.
- ✓ **Lower environmental impact:** Less use of fertilisers, leading to lower CO2 emissions.
- ✓ **Happy golfers:** Optimal playing conditions on the driving range and fairways.

Automation, using ECHO Robotics, has allowed the Naxhelet Golf Club to maintain high-quality grounds whilst reducing costs and the environmental impact.

# Automate ball collection on driving ranges

RP-1200 – RP-1250

TM-1050 – TM-2050 Driving range



## Patented technology

**ECHO Robotics golf ball pickers move around on driving ranges continuously to collect balls and transport them to the drop-off station. The automatic cleaner takes care of the balls and channels them to the ball dispenser.**

- Tank capacity: 300 balls
- Navigation in GPS or GPS-RTK mode
- Wisenav® available
- Automatic charging

## Performance and connectivity

**Thanks to automation, picking up balls on the driving range no longer puts employees at risk. The robot(s) are connected via the app and the platform.**

- Pick-up capacity: up to 15.000 golf balls / day
- Pick-up width: 95 cm
- Slopes of up to 30%
- Charges in a maximum of 75 minutes
- Fleet management
- Maintenance history

## Silence and protection

**ECHO Robotics golf ball pickers produce no noise pollution (max. 52 dB). Thanks to their anti-friction discs and patented pantographs, they are safe for both personnel and balls.**

- Limited weight: 70 kg (no ball denting)
- Cruising speed: 3.6 km/h
- Robust, durable material



# Parks and gardens

Partner to thousands of private gardens and public parks  
Our technology adapts to your green spaces



KSE

## Case study

# Katholieke Scholengemeenschap Etten-Leur (KSE)



Transforming the sport fields at the Katholieke Scholengemeenschap Etten-Leur (KSE) using an ECHO Robotics robotic mower

## Context

Before the introduction of a robotic mower, KSE's sports field was subjected to conventional mowing, which often left marks on the lawn because of the damp soil. Those marks compromised the quality of the pitch and created challenges in terms of maintenance and safety, especially in wet weather.



## ECHO Robotics Solution

Faced with these challenges, KSE adopted an innovative solution: installing an ECHO Robotics TM-1050 robotic mower. This technology provides precise, uniform grass cutting, and its programmable, automated operation reduces the risk of injury to pupils.

## Results

This solution has many advantages:

- ✓ **It is 50% less expensive** than conventional mowers.
- ✓ **It allows maximum use**, ensuring regular maintenance of the lawn.
- ✓ **The grass is cut perfectly and uniformly**, improving the appearance of the lawn.
- ✓ **It contributes to a significant (90%) reduction in CO2 emissions**, promoting a more sustainable approach to sports ground maintenance.

**In conclusion**, the introduction of the TM-1050 ECHO Robotics robotic mower has been a success for KSE, in terms of both efficiency and sustainability. This solution has improved the overall condition of the pitch, whilst giving pupils optimum conditions for practising sports safely, all year round.





Extreme sites

# Airport industries

A partner for organisations focused on sustainable development  
Easy, silent maintenance, even on extreme sites



## Schiphol

### Case studies

## Amsterdam Airport Schiphol



Amsterdam-Schiphol Airport

Use of ECHO Robotics robotic mowers at Amsterdam-Schiphol Airport

### Background

With its 6 runways and over 60 million passengers a year, Amsterdam-Schiphol Airport is Europe's 3rd largest airport. Successfully mowing the 11km<sup>2</sup> of grass around the runways is a real constraint with a traditional solution: negative impact of flight operations, tall grass and environmental impact.

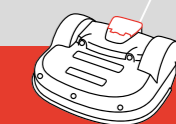

### ECHO Robotics solution

Faced with these challenges, in 2022 the airport began using two robots equipped with solar charging stations to assess their efficiency and adaptability. After an initial test phase, a 3rd robot will be commissioned in 2024.

### Results

There are many advantages to this solution:

- ✓ It is **no longer necessary to close a runway** to allow tractors to pass through, reducing the impact on air traffic control.
- ✓ The **use of solar-powered** robotic mowers reduces the airport's carbon footprint.
- ✓ The robots maintain an **ideal grass height** even during periods of rain or reduced visibility.
- ✓ **Shorter grass increases bird visibility** and this helps the bird patrol to contain the problem, reducing the risk of collision with aircraft.
- ✓ **No bird nests:** An academic study carried out by Dokkadeltaet Våtmarkssenter AS in 2021 at Stavanger Airport, Sola in Norway, states that the birds have stopped building nests in the areas that are now mowed with the xM-2050 series robotic mowers.
- ✓ Automated mowing **reduces human intervention** and the risks associated with the presence of personnel around runways.

In conclusion, the adoption of ECHO Robotics robotic mowers at Amsterdam Airport Schiphol represents a significant step towards safer, greener and more efficient management of the airport's extensive grass areas. The results of ongoing tests will determine the scope and speed of their full deployment from 2026.



# All features

## Features

MODEL	TM-2000 TURFMOWER CONNECTED	TM-1000 TURFMOWER CONNECTED	RP-1200 RANGEPICKER CONNECTED	TM-2050 TURFMOWER GPS-RTK	TM-1050 TURFMOWER GPS-RTK	TM-850S TURFMOWER GPS-RTK	RP-1250 RANGEPICKER GPS-RTK
<b>CAPACITY</b>							
Maximum working area (m <sup>2</sup> )	24,000	12,000	30,000	75,000	45,000	30,000	45,000
Recommended working area (m <sup>2</sup> )	20,000	10,000	24,000	55,000	35,000	22,000	30,000
# sports pitches / robot	1-2	1	-	1-5	1-3	1-2	-
Mowing / picking width (mm)	1,033	633	956	1,033	633	420	956
Speed (km/h)	3.6	2.8	3.6	3.6	2.8	3.6	3.6
Standard maximum slope	30%	35%	30%	30%	35%	30%	30%
Maximum slope with option (Kit)	45%	-	-	45%	-	-	-
Ball collection capacity/24 h	-	-	12,000	-	-	-	15,000
Basket capacity	-	-	320 - 350 balls	-	-	-	320 - 350 balls
<b>CUTTING / PICKING</b>							
# Mowing Heads	5	3	-	5	3	2	-
# Blades	15	9	-	15	9	6	-
Lowest cut (mm) minimum	20	20	-	20	20	20	-
Highest cut (mm) maximum	100	100	-	100	100	70	-
Cutting height setting	Electronic	Electronic	-	Electronic	Electronic	Electronic	-
Max Noise (dB)	52 at 1 m	52 at 1 m	61 at 1 m, 52 at 5 m	52 at 1 m	52 at 1 m	52 at 1 m	61 at 1 m, 52 at 5 m
<b>BATTERY</b>							
Battery Type	LiFePO4	LiFePO4	LiFePO4	LiFePO4	LiFePO4	LiFePO4	LiFePO4
Standard Battery capacity (Ah)	19.2	19.2	19.2	19.2	19.2	8.55	19.2
Battery voltage (V)	26.4	26.4	25.6	26.4	26.4	25.6	25.6
Average charging time (min)	80	80	80	80	80	55	80
Average mowing duration per charging cycle	110	280	240	110	280	120	240
Optional more powerful batteries (Ah)	-	-	-	-	-	-	-
Average yearly consumption (kWh)	830	580	620	830	580	400	620

MODEL	TM-2000 TURFMOWER CONNECTED	TM-1000 TURFMOWER CONNECTED	RP-1200 RANGEPICKER CONNECTED	TM-2050 TURFMOWER GPS-RTK	TM-1050 TURFMOWER GPS-RTK	TM-850S TURFMOWER GPS-RTK	RP-1250 RANGEPICKER GPS-RTK
<b>WEIGHT AND DIMENSIONS</b>							
Weight (kg)	71.9	52.9	85	71.9	52.9	25	85
Dimensions ((L)ength × (W)idth × (H)eight) cm	111x127x51	100x104x46	118x134x54	111x127x51	100x104x46	87x70x32	118x134x54
<b>SOFTWARE AND MONITORING</b>							
PIN Code security	Yes	Yes	Yes	Yes	Yes	Yes	Yes
GPS Localization	Standard	Standard	Standard	Standard	Standard	Standard	Standard
Server and App for robot management	Standard	Standard	Standard	Standard	Standard	Standard	Standard
<b>SMART FEATURES</b>							
Sonar for obstacle detection	5 Sonar units Detection of obstacles of diameter 7 cm x 40 cm height	5 Sonar units Detection of obstacles of diameter 7 cm x 30 cm height	4	5 Sonar units Detection of obstacles of diameter 7 cm x 40 cm height	5 Sonar units Detection of obstacles of diameter 7 cm x 30 cm height	2 sonar units Detection of obstacles of diameter 7 cm diam. x 40 cm height	4
Custom mowing cycle	Standard	Standard	-	Standard	Standard	Standard	-
Back to station via GPS	Yes	Yes	Yes	Yes	Yes	Yes	Yes
Multiple Starting Zones	Yes	Yes	Yes	Yes	Yes	Yes	Yes
Multi-terrain	Option	Option	Yes, more than 2	Option	Option	Yes	Yes, more than 2
Multirobot	Yes	Yes	Yes	Yes	Yes	Yes	Yes
<b>SECURITY</b>							
Lift sensors	Yes	Yes	No	Yes	Yes	Yes	No
Collision sensors	Yes	Yes	Yes	Yes	Yes	Yes	Yes
Tilt sensors	Yes	Yes	Yes	Yes	Yes	Yes	Yes
Safety bumper	Electronic	Electronic	Electronic	Electronic	Electronic	-	Electronic
Deflectors on cutting head	External heads	-	-	External heads	-	-	-

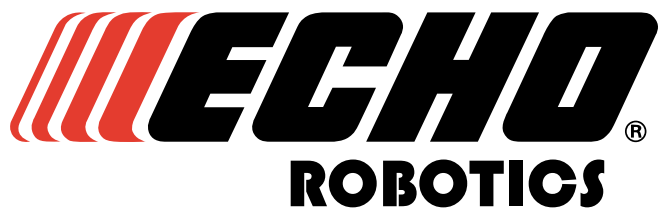

**Distributed by:**



**[www.centaur-asiapacific.com](http://www.centaur-asiapacific.com)**  
**[info@centaur-asiapacific.com](mailto:info@centaur-asiapacific.com)**

\*Hong Kong, Macau, Singapore, Malaysia, Vietnam, Thailand & Cambodia.

[www.echorobotics.com](http://www.echorobotics.com)